

MAY, 1932

# Radio Engineering

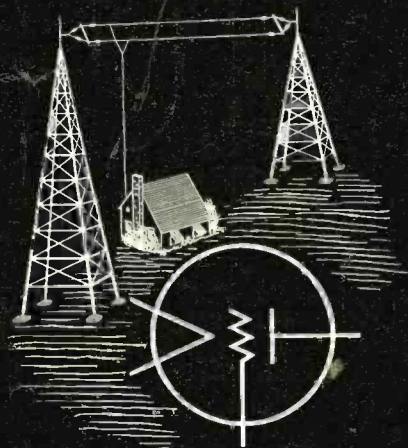

## IN THIS ISSUE



CHICAGO AND RADIO IN MAY

THE APPLICATION OF PERMEABILITY TUNING TO  
BROADCAST RECEIVERS

By R. H. Langley

RADIO DISSEMINATION OF THE NATIONAL  
STANDARD OF FREQUENCY

By J. H. Dellinger and E. L. Hall

FURTHER DESCRIPTION, AND CHARACTERISTICS OF  
THE WUNDERLICH RADIO TUBE

By Frederick E. Terman

LOUDSPEAKERS WITH INDEPENDENT CONTROL  
ADDED TO RADIO RECEIVERS

By W. L. Parsons

TWELFTH YEAR OF SERVICE

The Journal of the  
Radio and Allied Industries

# 'Unitary Structure'

## in TRANSMITTING TUBES

*assures matched tubes . . . enduring uniformity . . . long-lived performance*

Seldom have new products offered such a decided improvement over existing devices. The uniformity, performance and unique construction of Arcturus transmitting tubes establish a new basis for considering operation cost per hour.

The exclusive "unitary structure" principle employed in these tubes—the same as used in the well-known Arcturus *Blue* receiving tubes—assures unvarying uniformity even under most rigorous conditions. "Unitary structure" also insures matched tubes, so necessary for critical operation. These tubes are interchangeable with other makes whose last two digits are similar.

Write for technical data bulletins on the Arcturus Types E703-A, E711, E711-E, E745 (50-watt tubes) and E766 and E772 (mercury vapor rectifiers).

Arcturus Radio Tube Co., Newark, N. J.

### UNITARY STRUCTURE

Note the extreme rigidity of these tubes. The Unitary Structure principle of interlocking the elements maintains the precise interrelation of parts through interdependence. Each rugged element is securely clamped at the top and bottom and the complete assembly is a sturdy unit—insuring constant uniformity.

# ARCTURUS

*Quality Tubes for  
Transmitting, Receiving  
and Industrial Uses*



Is distribution sound? Does the advertising hit the market? How about overhead? How about the product itself?

Any radio manufacturer at this convention who asks himself these questions must come, sooner or later, to a consideration of the materials he uses. Which explains in part, at least, why Durez is being put to hundreds of new uses—not only in the radio industry, but in almost every other line of business!

*A better product, at low cost*

Durez frequently enables a manufacturer to make his product better, more quickly, and at less cost than he has made it before. A powdery, dust-like substance, Durez molds



under terrific pressure to take almost any required shape, pattern or design.

That finished product is tough, hard, durable. It needs no laborious finishing or polishing. It seldom chips or cracks. It has high tensile and dielectric strength. Its surface is naturally as smooth and beautiful as burnished ebony. Studs and inserts can be imbedded in the one molding operation. Intricate designs, trade-marks, insignias are accurately reproduced.

*People who "do it with Durez"*

The list of Durez users in the radio and electric fields alone reads like a Who's Who of business. Stewart-Warner, Delco, Turner Timer, Wagner Motor, Ford,

Westinghouse, Telechron, USL Battery—these are only a handful of hundreds of nationally known concerns who find Durez ideally suited to their needs. Remler Radio products, shown in the illustration, show how versatile this perfect molding compound really is.

This is a good time to check up on the way Durez fits into the plan of progressive manufacturers. Write now for free booklet. General Plastics, Inc., 55 Walck Rd., N. Tonawanda, N. Y. Also New York, Chicago, San Francisco, Los Angeles.

# DUREZ

THE PERFECT MOLDING COMPOUND

# RADIO ENGINEERING

Reg. U. S. Patent Office



*Western Editor*  
**ULMER G. TURNER**

*Editor*  
**DONALD McNICOL**

*Managing Editor*  
**F. WALEN**

Vol. XII

MAY, 1932

Number 5

## Contents

	PAGE
EDITORIAL .....	4
A CHRONOLOGICAL HISTORY OF ELECTRICAL COMMUNICATION—TELEGRAPH, TELEPHONE AND RADIO .....	6
CHICAGO AND RADIO IN MAY .....	13
RADIO TEST METHODS AND EQUIPMENT— <i>By William F. Diehl</i> .....	15
SOURCES OF LIGHT FOR TELEVISION <i>By A. Ernest Lyle</i> .....	16
THE APPLICATION OF PERMEABILITY TUNING TO BROADCAST RECEIVERS .....	17
<i>By R. H. Langley</i> .....	
RADIO DISSEMINATION OF THE NATIONAL STANDARD OF FREQUENCY .....	23
<i>By J. H. Dellinger and E. L. Hall</i> .....	
FURTHER DESCRIPTION, AND CHARACTERISTICS OF THE WUNDERLICH RADIO TUBE .....	25
<i>By Frederick E. Terman</i> .....	
LOUDSPEAKERS WITH INDEPENDENT CONTROL ADDED TO RADIO RECEIVERS .....	29
<i>By W. L. Parsons</i> .....	
FREQUENCY CONTROL MONITOR FOR BROADCAST STATIONS .....	30
PROGRESS IN RADIO TUBES .....	31

## Departments

NEWS OF THE INDUSTRY .....	34
NEW DEVELOPMENTS OF THE MONTH .....	38
INDEX TO ADVERTISERS .....	50

### HELP FOR BROADCAST STATIONS

IT WAS not only kindly consideration for the comfort of the goose that lays the golden eggs that prompted S. N. Shure, of Shure Brothers, Chicago, to launch a drive in the interest of radio advertised products. Mr. Shure has recognized the relationship between success for broadcast stations and success for everyone engaged in radio manufacturing.

The idea is that if every person directly or indirectly earning his and her living from radio sources would upon occasion sound the tocsin for and purchase products the manufacturers of which sponsor and pay for radio programs, there would follow a buying response that would rebound to the advantage of radio. Gains in sales by radio advertisers would strengthen the positions of broadcast stations supported by advertising revenue.

Here is a contribution to the radio industry which can be made by thousands of men and women without increasing individual or family expenses. It costs no more to purchase radio advertised products than products advertised by mailed circulars or other means.

**BRYAN S. DAVIS**  
*President*

**JAS. A. WALKER**  
*Secretary*

*Published Monthly by*

**Bryan Davis Publishing Co., Inc.**  
19 East 47th Street  
New York City

**SANFORD R. COWAN**  
*Advertising Manager*

**J. E. NIELSEN**  
*Circulation Manager*

Chicago Office—333 N. Michigan Ave.—Charles H. Farrell, Mgr.  
St. Louis Office—505 Star Building—F. J. Wright  
Kansas City Office—306 Coca Cola Building—R. W. Mitchell  
San Francisco Office—155 Sansome St.—R. J. Birch



Los Angeles Office—846 S. Broadway—R. J. Birch  
New Zealand—Tearo Book Depot—Wellington.  
Melbourne, Australia—McGill's Agency.

Entered as second class matter August 26, 1931, at the Post Office at New York, N. Y., under Act of March 3, 1879. Yearly subscription rate \$2.00 in United States. \$3.00 in Canada and foreign countries.



## TAKING THE BRAKES OFF THE AUDIO SYSTEM

**D**UE principally to the increase in power of broadcasting transmitters, radio engineers since 1927 have concentrated their attention on the radio-frequency system of the radio set.

Now, with the introduction of the type 46 Dual-Grid Power-Output Amplifier and its companion, the type 82 Mercury-Vapor Rectifier, set designers can "open up" on the audio system and provide a strong, new appeal to the set buyer in the form of gratifyingly greater realism.

The large reserve power available through the use of the 46 and 82 is an efficient preventative of "blasting", rattling, and distortion—bugaboos of sets whose power tubes were subject to overload. While the maxi-

mum available power may seldom be needed, the fact that it is available will make for better all-round performance. An 8-cylinder engine provides more horsepower than a light car ordinarily needs, but the car's average performance is better for the fact that such power is in reserve.

It should be borne in mind that even a barely perceptible increase in volume requires a very large increase in power supplied to the loud speaker.

Radiotrons 46 and 82, together with companion types 56, 57, and 58 of the new Super-phonics Series, enable set manufacturers to "step on the gas" with strikingly new receivers having an instantaneous attraction for the buying public.

**RCA RADIOTRON CO., INC. HARRISON, N. J.**  
*A Radio Corporation of America Subsidiary*

# RCA Radiotrons

THE HEART OF YOUR RADIO

# E d i t o r i a l

MAY, 1932

## BROADCASTING IN CANADA

AT Ottawa, Canada, a parliamentary committee has been holding hearings with the hope of bringing to the surface constructive ideas which might guide the government in formulating a national radio broadcasting policy.

The makeup of the Canadian House of Commons possibly includes some few members whose habits of thought have made it natural for them to lean toward paternalism in government. Fortunately, the majority of the members, of both political faiths, is made up of men who have learned that what the government engages to pay out in expense must be collected from the taxpayers.

At one of these hearings a representative of the All-Canadian Congress of Labor is said to have advocated the establishment of a powerful chain of broadcasting stations by the government.

If we may judge by the sanity exercised by Canadian legislators in handling liquor control, whereby millions of dollars are saved the taxpayers annually, and at the same time law observance is maintained, it seems unlikely that the parliament will saddle the entire cost of broadcast stations directly upon the taxpayers.

The entering wedge of government ownership of broadcast stations would no doubt open the way for government ownership of automobile factories and harvesting machinery establishments, and so on toward Communism.

If this should come to pass it would not be difficult to imagine certain of the pioneers who started Canada toward nationhood becoming restless in their graves.

## DR. KENNELLY RECEIVES INSTITUTE PRIZE

AT the Pittsburgh convention of the Institute of Radio Engineers, in April, Dr. A. E. Kennelly, of Harvard University, was awarded the Institute's Gold Medal, which each year goes to an engineer who has contributed largely to radio science.

The first book on the subject of wireless telegraphy was published in 1898. The seventh book, written by Dr. Kennelly, was published in 1906. This work was sent forth

to the students of that early day as "a simple treatise," and yet it was perhaps the first sound treatment of electromagnetic radiation.

In the intervening twenty-six years Dr. Kennelly has made many contributions of a mathematical nature which enabled other engineers to explore and to unfold. Dr. Kennelly was the first to advance a logical explanation of the mechanism of wave transmission over distances which involved the curvature of the earth. His announcement on this subject, dated March 15, 1902 (three months after Marconi's first trans-Atlantic tests) suggested the action of an upper reflecting layer in furthering the progress of waves sent out from a signaling station. This announcement preceded by three months the independent observation made by Oliver Heaviside, which carried the same significance.

The award of the Institute's gold medal to Dr. Kennelly will have the approval of engineers and physicists all over the world who have benefited from his writings and his teaching.

## FREE RADIO

It is illuminating to read the recorded arguments of those who criticize the present means of support for radio broadcast programs. For years past taxpayers have, ostrich like, allowed themselves to be "kidded" bankrupt by those who dealt in free education, free libraries, free concerts, free art galleries, free highways, etc. What an awakening there is in this year 1932 when taxpayers throughout the land have for the first time in decades time to analyze what the tax bill covers!

It is an old saw that "critics never have to make good." If anyone can work out a scheme of financial support for present day broadcasting, other than that now practiced, which will not mean added governmental expense and consequent added taxation, there is a present opportunity for him to become world famous.

*Donald Mc Nicol*  
Editor

# Self-tapping Screw economies do not depend on volume production

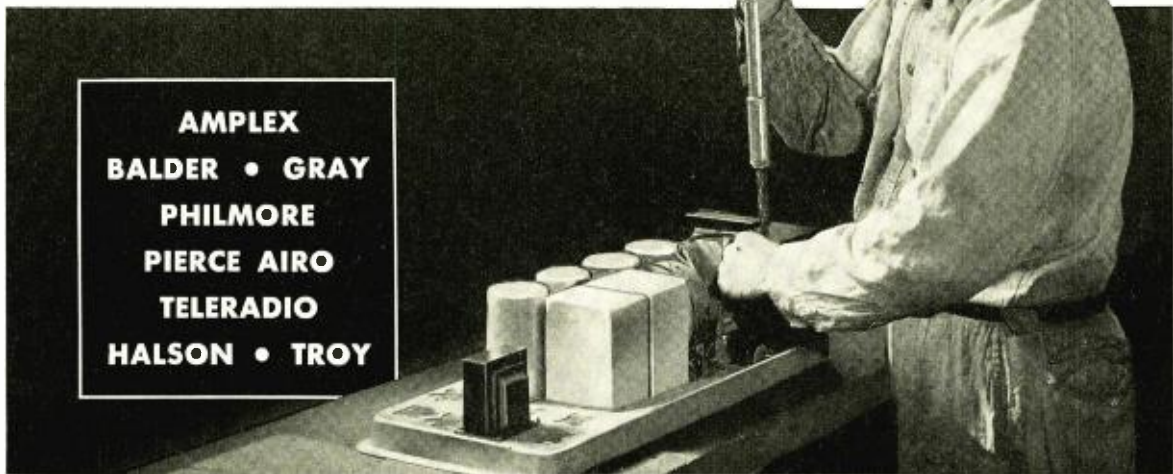

**AMPLEX  
BALDER • GRAY  
PHILMORE  
PIERCE AIRO  
TELERADIO  
HALSON • TROY**

## Unit Savings are the same for one or a thousand sets

To obtain the substantial assembly economies and other advantages which Self-tapping Screws bring to radio manufacture, it is not necessary to have a volume production like that of Philco, Zenith, Stromberg-Carlson, Crosley and other large concerns. The percentage of economy on a single unit per day is the same as on a thousand sets per day.

Listed in the illustration above are eight of the many radio manufacturers with comparatively small production volume who make better and cheaper assemblies with these unique Screws. Philmore Radio, for instance, states:—  
"Adoption of Self-tapping Screws for fastening units

and dial panels to chassis, speeded-up our production and reduced costs by eliminating tapping and unhandy nuts and bolts. Also the Screws made possible an improvement in design" Offering all those advantages, Self-tapping Screws also make stronger fastenings — fastenings that do not jar loose in transit.

### No special equipment or skill required

You need no special equipment or skill to use Self-tapping Screws. Find out what they will save you. Our Assembly Engineers will tell you, if you attach a description of one or more assemblies when you mail the coupon below.



**Type "Z" Hardened Self-tapping Sheet Metal Screws**  
For joining and making fastenings to sheet metal up to six gauge; also aluminum, die castings, Bakelite, etc. Simply turn Screw into drilled, pierced or molded hole. It forms a thread in the material as it is turned in. Can be removed and replaced.



**Type "U" Hardened Metallic Drive Screws**  
This type of Self-tapping Screw is used for making permanent fastenings to iron, brass and aluminum castings, steel, Bakelite, Durez, etc. Just hammer the Screw into a drilled or molded hole. It forms a thread in the material as it is driven

## PARKER-KALON *Hardened* Self-tapping Screws

PAT. IN U. S. AND FOREIGN COUNTRIES



← Application to well known radios.....Scientists Explain Fastening Security →

PARKER-KALON CORPORATION, Dept. L, 190-198 Varick Street, New York, N. Y.

- Send free booklets on Security and Uses of Self-tapping Screws in radio assemblies.
- Tell me whether I can successfully use them for fastenings described on attached sheet.

Name and Company.....

Address.....



# A chronological history of electrical communication —telegraph, telephone and radio

▲

This history was begun in the January, 1932, issue of RADIO ENGINEERING, and will be continued in successive monthly issues throughout the year. The history is authoritative and will record all important dates, discoveries, inventions, necrology and statistics, with numerous contemporary chronological tie-in references to events in associated scientific developments. The entries will be carried along to our times.

▼

## Part V

- 1850 (189) A submarine telegraph line is laid across the English channel, but due to failing insulation was operated only a short time.
- (190) During this year considerable improvement is made in telegraph line construction methods. The House lines built between New York and Buffalo and between Buffalo and Cincinnati are the most substantial lines thus far built.
- (191) Judge Samuel L. Selden, of Rochester, N. Y., secures the agency for the extension of House system lines throughout the United States.
- (192) Charles T. Chester, in America, develops a standard telegraph battery, employing dilute sulphuric acid only.
- (193) A Bain telegraph line is built by Henry D. Rogers between New York and Washington, the main office at 29 Wall St., New York. A New York and Boston Bain line, called the Merchants Line opened under the presidency of Marshall Lefferts.
- (194) Anson Stager employs a common battery to feed a number of individual telegraph circuits. Previously each line had its own battery.
- (195) W. M. Swain elected president of the Magnetic Telegraph Company, operating the line between New York and Washington. (Remained president until 1858.)
- (196) Prof. Nollet, of Brussels, Belgium, plans large magneto machines for electric lighting purposes.
- (197) Bakewell, of London, invents a facsimile handwriting telegraph.
- (198) C. S. Bulkley, in America, invents an automatic telegraph repeater.
- (199) William Sturgeon dies. (Born in England 1783.)
- 1851 (200) After the failure of previous attempts to maintain cables, and aerial wires across the Hudson river, Simeon Borden, civil engineer, erects a pole-supported line between Washington Heights, N. Y., and the Palisades, N. J., for the Magnetic Telegraph Company.
- (201) Dumont, in England, procures a patent (February) for a central office telegraph switching system.
- (202) Farrar, in England, writes: "If current power could be varied by some slight variation of a vibrator, to be affected by the atmosphere as the tympanus of the ear is, the supposition is that the sounds of the voice might be reproduced."
- (203) Henry S. Potter elected president of the New York and Mississippi Valley Printing Telegraph Company (April 2), the immediate predecessor of the Western Union Telegraph Company. Mr. Potter was the first president of the Western Union Company, holding that position until July 30, 1856.
- (204) Hans Christian Oersted dies. (Born Denmark, 1777.)
- (205) Aurora borealis electrical disturbances interfere with telegraph line operation throughout the New England states.
- (206) Heinrich Ruhmkorff, in Germany, constructs his first induction coil.
- (207) During this year there were over fifty different telegraph companies doing business in the United States.
- (208) The telegraph is first used for train-order movement of railway trains (on the Erie Railroad).
- (209) A Bain telegraph line is constructed between New York and Buffalo by Henry V. O'Reilly. Marshall Lefferts served as president of the company. This line was extended also between Portland, Maine and Boston, Mass., and between Boston and Montreal. John W. Wilkins, an English telegraph electrician, inventor of a sensitive relay, is engaged by O'Reilly.
- (210) A cable containing four copper wires, insulated gutta-percha and surrounded by tarred hemp and protected by ten galvanized iron wires wound spirally about it, laid across the English Channel by a company of British and French capitalists. Opened for service on November 13. The cable weighed seven tons to the mile and was twenty-five miles long. This, the first successful submarine cable, remained in service many years.
- 1852 (211) Farmer and Channing apply the telegraph to fire-alarm signaling purposes in Boston, Mass.
- (212) Aurora borealis disturbances (February 19) interfere with telegraph line operation in the North-eastern states.
- (213) Latimer Clark, in England, confirms theories previously suggested by Ronalds and Faraday in regard to retardation of signals in long cables, as a result of electrostatic capacity.
- (214) Referring to the proposal to connect Europe and America by telegraph cable, Alexander Jones, in his book on "The Electric Telegraph," published in New York, this year, says on page 6: "All idea of connecting Europe with America by lines directly extending across the Atlantic is utterly impracticable and absurd."
- 1853 (215) Moses G. Farmer, of Framington, Mass., experiments with a system of duplex telegraphy.
- (216) Professor Buff, of the University of Giessen, publishes a paper dealing with the electrical properties of flames. He concludes that gaseous bodies which have been rendered conductive by heating are capable of exciting other conductors, solid as well as gaseous, electrically. Insulated electrodes of platinum were inclosed in a glass container and the exterior of the container subjected to the heat of a spirit lamp. When the heat was most intense an exterior battery circuit connected to the electrodes, through a galvanometer, indicated the passage of current.
- (217) Arago dies. (Born in France, 1786.)
- (218) Gintl, of Vienna, Austria; also Siemens and Halske, in Germany, bring out systems of duplex telegraphy. Neither of these systems was successful on long lines.
- (219) The first telegraph convention is held, in Washington, D. C. (March 5).
- (220) The House telegraph system is placed in operation on 1,200 miles of line in Cuba.
- (221) The Erie Railroad Company has 497 miles of telegraph line in operation, with fifty-two offices. Sixty-five telegraph operators are employed by the company.
- (222) During the year six submarine cables are laid, connecting England with Ireland, Scotland and the Continent. The longest cable laid is 100 nautical miles in length. The cable between England and Ireland has six conductors.

(To be continued)





*Broadcast Station WEAf—50 kilowatts*

# Transmitting Radiotrons

that surpass even RCA Victor's previous high standards

At this time we especially invite the profession to inspect the new Transmitting Radiotrons. These new tubes have established feats of performance of which RCA Victor has good cause to be proud.

The new Transmitting Radiotrons are products that the technical man might expect to come from radio's foremost engineering organization.

TRANSMITTING RADIOTRON SALES  
ENGINEERING PRODUCTS DIVISION

## RCA Victor Co., Inc.

*A Radio Corporation of America Subsidiary*

Camden, N. J.



"RADIO HEADQUARTERS"

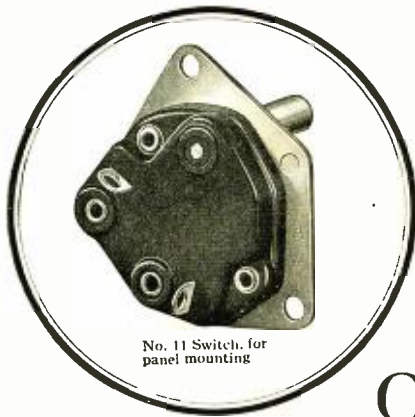

No. 11 Switch, for panel mounting

# Announcing No. 11— the new, long-lived, low-contact resistance snap switch with positive kick-off . . .

OF primary interest to set manufacturers is the announcement of our new snap switch. This is now available in two forms, No. 11, a separate S. P. S. T. switch for panel mounting, or Type "T," in combination with our complete line of positive-wiping-contact volume controls.

In either type this new switch has an extremely low and a remarkably uniform contact resistance. It possesses exceptionally long life, as proved by our extensive breakdown tests. Because of its positive kick-off the opening or closing of the circuit is doubly assured.

The operating torque of No. 11 is the lowest of any commercial switch now offered the set manufacturer. In addition to its low torque this new switch operates with the smallest knob movement of any switch on the market, making available the maximum length of resistance element for controlling volume or tone.

Other features of this switch that you will be quick to appreciate are its "cold" cam, which is double bearing and cannot bind or wobble in operation; the wide separation of all live parts from the cam; electrostatic shield, that effectively prevents hum pickup by the volume control from live parts of the switch; heavy silver-plated terminals, insuring low contact resistance and ease of soldering; and approval by Underwriters' Laboratories for 3 A, 125 v., 1.5 A, 250 v., ac. or dc. We can supply these switches with or without leads.

*We invite inquiries from interested manufacturers regarding this new switch, either for panel mounting or in association with our complete line of wire wound or carbon element volume and tone controls. Write us fully regarding your needs and allow us to submit samples made to your specifications.*



No. 20 Series, with switch



No. 70 Series, with switch

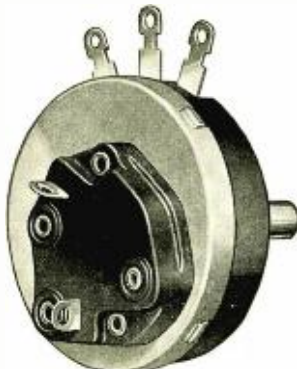

No. 80 Series Single Unit, with switch

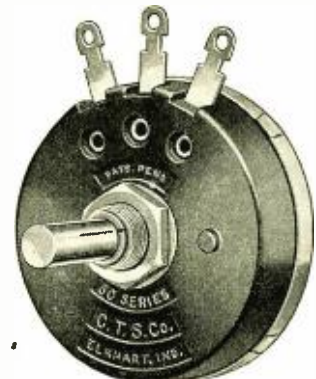

No. 80 Series Single Unit, without switch



No. 80 Series, Type H, with switch

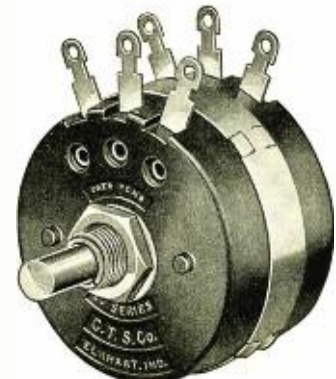

No. 2-80 Series Tandem Unit, without switch

## CHICAGO TELEPHONE SUPPLY CO.

HERBERT H. FROST, Inc. SALES DIVISION  
ELKHART, INDIANA



## THE FUTURE OF A GIANT INDUSTRY

As the towering heights of Radio City become a reality they will foreshadow the radio industry of the future.

To the public this project will symbolize a great industry. To the radio engineer it will symbolize a new era built around the electronic theory.

The part that copper plays in this development cannot be over-emphasized.

Among the most vital components of every radio system . . . broadcasting, receiving, television or communication . . . are the wires that conduct and the coils which transform the electrical energy.

Inca magnet wire and coils have demonstrated in many critical applications their fitness for radio's most exacting needs.

# INCA

**MANUFACTURING DIVISION**

of Phelps Dodge Copper Products Corp., Fort Wayne, Ind.

*Eastern Office:*  
40 Wall St., New York, N. Y.

*Western Office:*  
2375 E. 27th St., Los Angeles, Calif.

# Assured Performance

The Type 60 Frequency Monitor embraces features not found in any similar unit. Exhaustive tests have shown conclusively that its performance greatly exceeds the requirements of General Order 116.

## Precision

Maximum frequency error is the drift over one week. Monitor may be checked against Station WWV (Bureau of Standards, Washington, D. C.) and, if necessary, easily corrected.

## Universal

The International Type 60 Unit, without change, will check ANY U. S. frequency.

## Accuracy

Frequency adherence, plus or minus 5 cycles at 1,000 kc. Frequency variation from one cycle in ten seconds to 100 cycles per second may be observed.

## Stability

The quartz crystal is clamped, thus eliminating frequency changes due to vibration.

## A. C. Operated Immediate Delivery

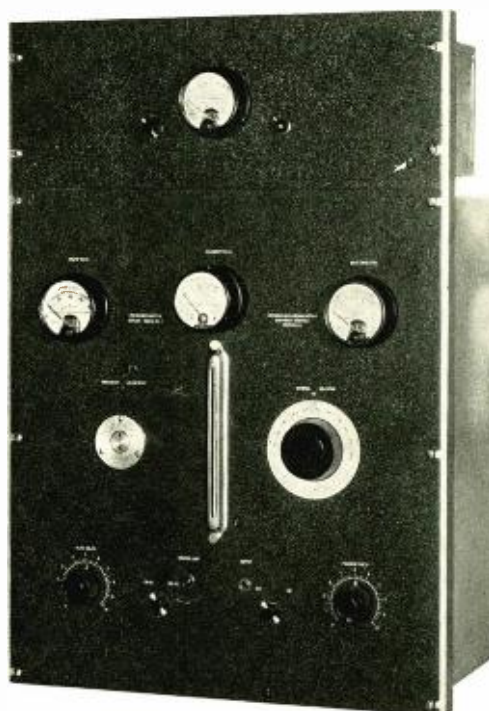

*Type 60 Universal Frequency Monitor  
with  
Type 100 Frequency Meter*

*Write for Bulletin 17, which contains  
price list, and describes this apparatus  
in detail.*

**International Broadcasting Equipment Co.**  
3112 West 51st St. Chicago, Illinois

# SHAKEPROOF

*No More  
Loose  
Connections*



EVERY day more manufacturers are realizing the fact that faulty lock washers are the greatest cause of poor performance. They have found out that loose connections hinder sales—increase service costs and discourage valuable customer good will.

That's why Shakeproof is winning its place on a steadily increasing number of products. This positive locking principle defeats vibration because its twisted teeth bite into both the nut and work surface, forming a solid contact and an absolutely

tight lock. In fact, as vibration increases the teeth bite in deeper and only applied force can release their hold.

Take advantage of this profit saving lock washer and give your product the protection it deserves. You can prove the worth of Shakeproof by a trial in your own shop. Free testing samples will be gladly sent on request—mail coupon today.

## SHAKEPROOF Lock Washer Company

*(Division of Illinois Tool Works)*

2509 North Keeler Avenue, Chicago, Illinois

U. S. Patents  
1,419,564  
1,604,122  
1,697,964  
1,782,387  
Other patents  
pending.  
Foreign Patents.



Type 12. Internal For S. A. E. and Standard Machine Screws

Type 11. External For Standard Bolts and Nuts

Type 15. Countersunk For all Countersunk Screws

Type 20 Locking Terminals For Radio and Electrical Work

Shakeproof representatives are located in the following cities:

- |               |              |               |                  |                          |           |
|---------------|--------------|---------------|------------------|--------------------------|-----------|
| New York City | Philadelphia | Boston        | Pittsburgh       | Schenectady              | Cleveland |
| Detroit       | Toledo       | Cincinnati    | Birmingham, Ala. | Dallas, Texas            | Milwaukee |
| Los Angeles   | Seattle      | San Francisco |                  | Toronto, Ontario, Canada |           |

### COUPON

Gentlemen: We want to test your Shakeproof Lock Washers. Kindly send us samples as indicated.

Type ..... Size .....

Type ..... Size .....

Firm Name .....

Address .....

City ..... State .....

By ..... Title .....

# 15 Textolite laminated parts were used in this timing device

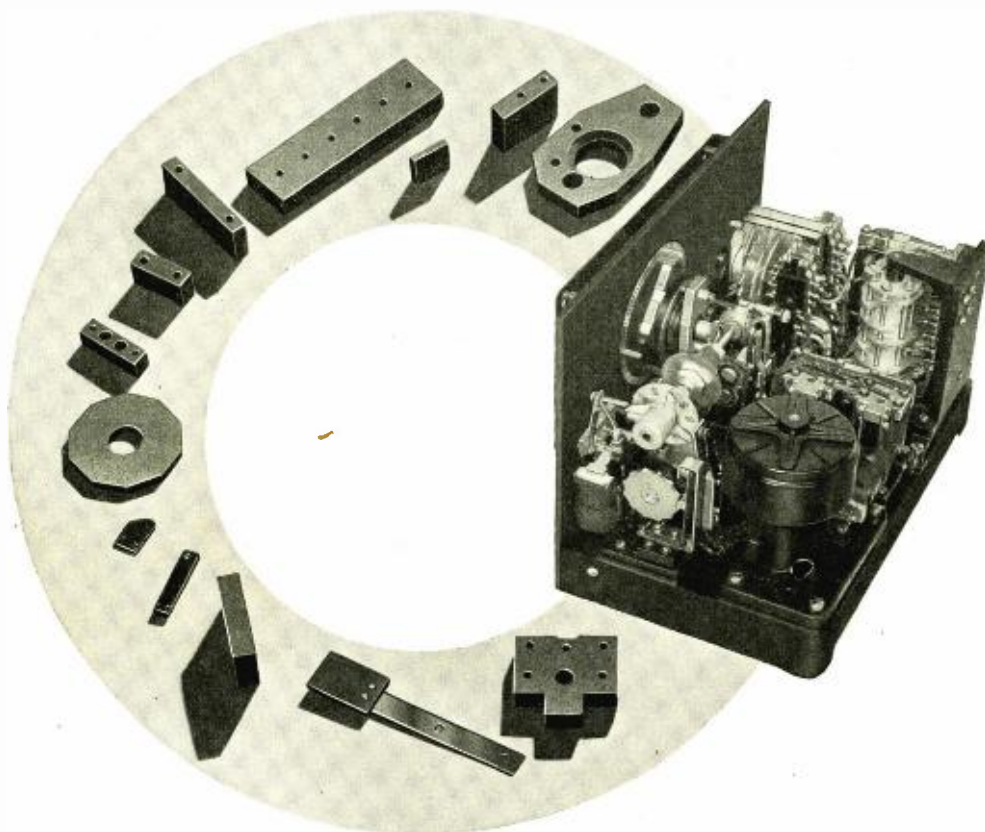

**OTHER PRODUCTS:**  
*Textolite molded*  
*Cetec cold-molded*

**EASTERN FABRICATOR**  
General Fabricating Co.  
37 East 18th Street  
New York City

**WESTERN FABRICATOR**  
Electrical Insulating Corp.  
308 Washington Street  
Chicago, Ill.

**T**EXTOLITE laminated, a General Electric product, manufactured in sheets, tubes, and rods, was chosen for the fabrication of these parts because of its dependable uniformity, high dielectric and mechanical strength, and the ease with which it can be fabricated.

An increasing number of manufacturers in the electrical, radio, and electronic fields are using Textolite laminated—it assures positive, dependable operation of their products.

Investigate Textolite laminated. By adapting it to your product, you may be able to effect great savings for your company.

Ask for a copy of GEA-1458. Simply address General Electric Company, Plastics Department, Meriden, Conn.

831-15

# GENERAL ELECTRIC

# RADIO ENGINEERING

Production, Administration, Engineering, Servicing

MAY, 1932

## Chicago and radio in May

**R**EASONS why every radio dealer and jobber should attend the eighth annual RMA convention and trade show at Chicago during "radio week," beginning May 23, are detailed in a statement issued by President J. Clarke Coit of the RMA.

"No live radio distributor or dealer can afford to miss the annual RMA trade show in Chicago, May 23-26," said President Coit. "Virtually every prominent manufacturer will display and to the trade only the newest radio and electrical products and lines for the forthcoming year. The contacts at this annual industry gathering are invaluable to those who attend in Chicago. Never before were so many difficult and important problems pressing upon the industry. The problems of distribution are especially complex and rapidly changing. The closest contacts with not only the newest radio and electrical

products, but the newest and changing channels of distribution are essential. The opportunities of those who attend at Chicago during radio week are obvious.

"No individual who expects to profit in the selling, engineering or manufacturing of radio can afford to miss being present at Chicago during the week of May 23. Practically every one of any importance in these branches of the trade will be there during "radio week." The opportunity offered to view new merchandise, styles and trends, to become posted on manufacturing and technical developments, to make personal contacts, to secure the opinion of all those vitally interested in radio is invaluable. At Chicago it will be possible for an entire selling or buying organization to make business contacts, secure information and in a few days do what would otherwise take many months and at much greater expense.

"There will be a cordial welcome for everyone interested in radio at Chicago and the business contacts possible there, May 23-26, are incalculable."

Final plans for the big annual radio gathering at Chicago and for vigorous opposition in the Senate against the proposed radio sales tax have been made by the RMA board of directors. J. Clarke Coit, of Chicago, president of the Association, presided at the meeting at Hot Springs, Va., on April 8, which required special RMA cars for directors from the east and west. In addition to the industry gathering at Chicago in May and the sales tax, closer relations with jobbers and dealers, policies in connection with public radio shows, engineering developments and others, were considered. Nominations of new RMA officers to be elected at the May membership meetings in Chicago were approved by the Board. N. P. Bloom, of Louisville, Ky., third vice-president of the RMA, is chairman of the nominating committee.



J. CLARKE COIT  
President, RMA

### Short-Wave Sets

Following its policy in connection with television and other new radio developments, to correctly inform the public regarding limitations of short-wave reception, a statement will be issued soon by the RMA. The statement on the development of short-wave apparatus and reception was prepared by the association's engineering division of which Dr. C. E. Brigham, of Newark, N. J., is director, and was approved by the RMA board of directors. The statement is designed to promote sales and also meet a situation harmful to sales through exaggerated claims and advertisements in connection with short-wave reception.

### Radio Jobbers' Relations

An intensive study of radio distribution is to be made by the RMA. The entire problem of wholesale distribution of radio through jobbers, manufacturers' representatives and, to some extent, in connection with retail sales is planned, by order of the RMA board of directors. A special committee has been authorized and will be appointed soon by the president of the RMA for the work. Included in the committee's survey will



N. P. BLOOM  
Third Vice-President, RMA

be the problem of trades organizations with the intent of the entire inquiry to increase cooperation between distributors and manufacturers and the RMA.

**Public Shows**

The value of public radio shows to manufacturers will be considered by a special committee of the RMA to determine the association's future policy in connection with public shows. For about two years the RMA refrained from sponsoring or endorsing any public shows or radio exhibitions other than its own well-established annual trade show, from which the public is excluded and to which only the trade is admitted. The committee to study the public show question, especially problems relating to the New York and Chicago public shows held in past years, will be appointed soon.

**School Promotion Manual**

Manuscript and photographs for the manual being prepared by the RMA in cooperation with the U. S. Office of Education, Department of the Interior, to promote installations of radio and sound equipment in schools, have been assembled. The special RMA committee engaged on the sales promotion project, headed by A. C. Kleckner, of Racine, Wisconsin, plans to complete and issue the manual late in May or soon thereafter. Many RMA manufacturers of radio and sound apparatus have contributed valuable engineering assistance and data for inclusion in the school installation manual which is expected to develop wide equipment of schools and result in sales. The manual is especially designed to assist and advise school authorities and others in



**B. G. ERSKINE**  
Chairman, Show Committee.

the use of radio in education and will be an authoritative and official manual for educators. The manual is to be distributed not only by the RMA and manufacturers, but also as an official document of the Government with the approval of the Office of Education, U. S. Department of the Interior.



**E. V. HUGHES**  
Director, RMA

Left:  
**ARTHUR MOSS**  
Director, RMA



Right:  
**W. J. BARKLEY**  
Director, RMA

**Railroad Rate Reductions Sustained**

Greatly reduced railroad rates on receiving sets which were secured nearly two years ago by the RMA and attacked by interests of Omaha, Nebraska, have been sustained by the Interstate Commerce Commission at Washington, according to advice to the RMA traffic bureau. The action of the Federal Commission dismissing complaints against the new rates is another important victory for the RMA and its traffic bureau. The ruling permits the reduced rates on receiving sets to remain in effect and they save set manufacturers about ten per cent on shipments. A total saving last year was estimated at \$1,500,000.

**Automotive and Aeronautic Radio**

To promote and stimulate automotive radio and cooperative engineering work in its development, the Society of Automotive Engineers has been invited by the RMA to form a joint committee for engineering studies in connection with automotive radio. The National Automobile Chamber of Commerce also has been consulted in the matter which was suggested by Dr. C. E. Brigham, chief of the RMA engineering division, and Virgil M. Graham, chairman of the RMA standards committee.

Work in the development of aeronautic radio also has been done by the RMA liaison committee with the Department of Commerce organizations on aeronautic radio.

**Radio Standards**

Under the direction of Virgil M. Graham, of Rochester, N. Y., chairman of the RMA standards committee, many important standards for radio manufac-





ture have been considered at committee meetings and by letter ballot with results distributed to RMA members. The RMA was invited to representation in the Acoustical Society of America and the appointment was accepted by Director Brigham of the engineering division. Much work also has been done by the section committee on radio of the American Standards Association.

In addition to the important work of standardizing radio manufacture more effectually, service, safety and other problems have been considered by other engineering divisions. A meeting of the service section was held February

11 at New York by E. M. Hartley, of Camden, N. J., chairman.

Important standardizations on correct dial markings for short-wave, long-wave and all-wave receivers were made at a meeting of the engineering committee on receivers March 24. A. Crossley, of South Haven, Mich., is chairman of this committee, which also made standard recommendations for a new six-pin tube socket to fit the new six-prong tubes recently released by tube manufacturers.

A meeting of the vacuum tube committee, of which Roger M. Wise, of Emporium, Pa., is chairman, was held

April 6 at Pittsburgh during the spring convention of the Institute of Radio Engineers. At Pittsburgh also the RMA standards committee on component parts, of which D. S. W. Kelly, of Milwaukee, Wisc., is chairman, held a meeting.

Many of the new and valuable engineering standards have been distributed to RMA members by Chairman Graham of the standards and engineering information section. Every effort is being made to maintain the RMA manual of standards and make it more useful and up-to-date for RMA members.

# Radio test methods and equipment†

By WM. F. DIEHL\*

THE paper deals with the test engineering division of the RCA-Victor Company, Inc., where radio activities of several manufacturing plants were centralized. The problems of this type of organization to control adequately the quality of, not only broadcast receivers and combination instruments, but also sound equipment, direction finders, special receivers, and miscellaneous instruments are discussed. Special emphasis is given to descriptions of the particular methods and apparatus used in this control of quality.

The quality control of manufactured products by inspection groups and testing devices is not new to modern industry. In the larger manufacturing plants, consideration has been given to the particular setup for handling this inspection, and the equipment employed and methods resorted to are frequently changed to meet the high standards required by the industry.

Certain industries depend on visual inspection and simple mechanical checks, others on elaborate chemical analyses, and some on electrical measurements. In our plant, however, use is made of all such tests in the control of raw material, component parts, and the finished product. By utilizing laboratory methods and equipment modified to meet production requirements, we are able today to effect accurate control in the factory to a higher degree than was even known to the laboratory in the earlier days.

The more exacting requirements demanded of radio merchandise today, makes it impossible to resort to the old-fashioned method of simple listening

tests by skilled operators. Furthermore, it is important not only to know the performance of the product as shipped, but to have assurance that materials and component parts purchased from outside suppliers are according to specifications, which if met, will assure us that continued service under various operating conditions will not materially affect this performance.

Equipment used in different laboratories must be standardized and values used in the test specifications must be determined by standard equipment from which secondary standards can be made; thereby, insuring consistent results.

The principal test equipment and

methods of test which will be discussed and described, are as follows:

1. Chassis and final overall sensitivity.
2. Hum.
3. Selectivity and i-f. alignment.
4. Continuity.
5. Method of checking gang capacitors.
6. Inductance of iron core reactors.
7. Test on electrolytic capacitors.
8. Filter capacitor life test equipment.
9. Automatic power transformer test.
10. Hum analysis.
11. Flux density test on speakers.
12. Visual testing.

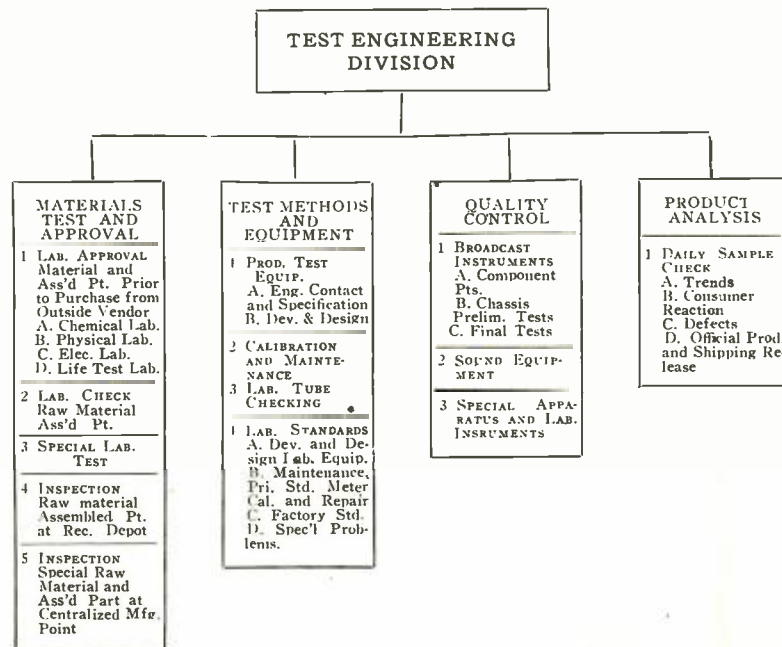

†A paper presented at the I. R. E. convention, Pittsburgh, Pa., April 8, 1932.  
\*RCA Victor Company, Camden, N. J.

# Sources of light for television

By A. ERNEST LYLE\*

**L**IGHT sources as utilized in television reception are of two main types, the first a "flat plate" lamp in which the glow discharge is uniformly distributed over a cathode one or two inches square and the second a crater or "point source" lamp in which the glow, while greatly intensified, is restricted in size to a small area usually between 10 and 50 thousandths of an inch in diameter.

The "flat plate" type lamp finds its employment principally in conjunction with simple Nipkow scanning discs of the punched or drilled, hole type. Because of the poor efficiency of such scanning systems, approximately only 1/4200 or less of the light available being viewed at any given instant, it is of utmost importance that the lamp used in conjunction with such a disc be of as high an efficiency as is compatible with a reasonable life expectancy.

## New Flat Plate Lamp

There has recently been developed a novel type of "flat plate" lamp having among its advantages an extremely high efficiency, a greatly improved frequency response, and an increased useful life.

This "wall electrode" television lamp achieves its high efficiency from the formation of an intense glow discharge by positive ion bombardment of a specially treated, flat cathode. The glow is restricted to the front portion of the cathode in order that the entire energy applied to the tube may be utilized as useful light. Operating at 20 ma. the light output is in excess of 4 C.P.

Modern television, which, after all, is merely the resolving of a picture, and its recombination from numerous component parts, requires a wide frequency band. To obtain the detail which alone makes a television picture recognizable and comparable with other pictures, a band of from 30 to 50 kilocycles must be employed. During the early stages of development work it was found that the

\*Chief Engineer, Cable Radio Tube Corpn.

## Descriptions of modern type, flat plate and crater lamps for television uses.

average commercially available television lamp responded very poorly to the higher frequencies. This, seemingly, was due to the negative charge which accumulated during operation upon the glass envelope and acted as a third electrode—a negatively charged grid—tending to increase the de-ionization time of the gas with the result that the lamp suffered greatly from frequency restriction, often failing to respond to most of the high frequency signal component.

From this study resulted the "wall electrode" type of television glow lamp in which the anode is in the form of a metallic coating on the inside of the lamp envelope itself. In this way the effect of the negative charge on the wall is avoided.

This type of construction offers other important advantages both from the standpoint of efficiency and increased life. During manufacture the metals vaporized to form the wall electrode, exerting a powerful getter action insuring an exceedingly pure gas content. Similarly, during life this large exposed getter area, continually activated by the gas discharge, greatly retards one major cause of tube failure—gas contamination—and thus increases the expected tube life.

The characteristics of the wall electrode television lamp are as follows:

Cathode surface.....	1 inch by 1 inch
Ignition voltage.....	130-140-v. d-c.
Operating voltage.....	120-150-v. d-c.
Maximum d-c. operating current....	20 ma.
Recommended d-c. operating current .....	10-15 ma.
Ignition current (approx.).....	5 ma.
Extinguishing current (approx.)....	2 ma.
D-c. resistance at 20 ma. (approx.) .....	6,500 ohms
Dynamic impedance at 20 ma. (approx.) .....	1,000 ohms
A-c. power necessary for complete modulation of light values at:	
10 ma. operating current.....	35 milliwatts
20 ma. operating current.....	175 milliwatts

## The Crater Lamp

Another widely employed television lamp is the so-called crater or point source type used generally in conjunction with television projecting apparatus such as lens discs, mirror wheels and other optical scanning arrangements.

The requirements for a light source of the crater type differ considerably from those of the flat plate type. In the

crater lamp the light must be of an extremely high intensity and restricted to a small area, generally within 0.0001 to 0.0025 square inch, in order that it may be sharply focussed as a tiny intense spot on the screen.

The gas discharge must be of a type susceptible to rapid modulation without undue lag and because of the amount of heat generated in a constricted space, special provisions for heat radiation must be incorporated.

Recently a crater lamp having these characteristics was developed and is now finding a wide application. This lamp is of a particularly rugged construction and has its light beam propagated in a direction parallel to the main tube axis. Its angle of radiation is extremely narrow, in order that all generated light may be utilized, even with a small diameter lens. It is so designed mechanically that it may readily be employed with lenses of focal length as short as one-half inch.

## Light Output

The intrinsic brilliancy is of a high order. A unique design and a specially developed coating process, incorporating the use of radio-active elements, not only assures improved performance and lowered ignition voltage, but also that a large percentage of the total radiation falls within the visible portion of the spectrum. The light output averages about 0.75 candle power per square mm. of light emitting surface.

The glow discharge in this crater lamp is concentrated in a small canal which compresses the Faraday dark space to an infinitesimal thickness and results in the discharge persisting in a semi-unstable condition, thus lending itself well to modulation at high frequencies.

The operating impedance of gas discharge lamps of the crater type is extremely low and as the frequency range to be accommodated is wide, extending to approximately 50 kc., the difficulty of obtaining an impedance match between the output tube and the crater lamp is very great, so great, in fact, that it generally is not even attempted.

Thus the problem of crater lamp modulation generally resolves itself simply into one of obtaining a sufficiently large peak current swing from the output tube. For complete modulation of light values the peak a-c. current must be of sufficient magnitude to approach the value of the d-c. operating current.

Particular study has been made to design a rugged tube electrically as well as mechanically. The crater lamp here described, while rated at 25 ma. d-c., operating current, will safely permit considerable overloads for short periods.

(Concluded on page 24)

# The application of permeability tuning to broadcast receivers †

By R. H. LANGLEY\*

**T**HE chief difficulty with condenser tuning is that it is inherently incapable of producing uniform performance. By the use of compound couplings it is possible to secure reasonably uniform gain, but no arrangement so far proposed will give uniform selectivity and fidelity except at the expense of a large decrease in the efficiency of each circuit. It was realized as early as 1922 that inductance tuning offered decided advantages in the solution of this problem.

Inductance tuning is a general term for any method in which the total effective inductance in the circuit is varied. The variometer, which enjoyed a considerable vogue in 1922-1924, was a device for securing this variation. The reason it did not succeed was because its resistance varied with frequency in exactly the same way as the resistance of the fixed inductance of the condenser tuned systems, and it was therefore equally incapable of producing uniform performance.

There have been other suggestions for varying the inductance. One proposed to decrease the inductance by introducing a copper shield. The eddy currents in this shield effectively decreased the inductance, but they simultaneously increased the losses and, therefore, the effective resistance, at a rate even greater than in the variometer. Here again there was no possibility of securing uniform performance over the range.

The problem, however, is not to produce a variation of inductance, but to produce a simultaneous and proportional variation of inductance and resistance. The recognition of this fact has come only recently. This is the result secured in the new tuning method which

we are examining tonight. It is called "permeability tuning" first to distinguish it from other methods of inductance variation, and second, because this term is adequately descriptive of its mechanism.

With permeability tuning, it is not only possible to secure uniform performance over the broadcast range, or any other range, on all three counts, with a degree of mechanical and electrical simplicity quite beyond anything so far suggested, but other new and valuable results can be secured.

It now becomes necessary to direct attention to a fact which has been too much neglected in the study of the problem of selectivity. The channels on which broadcasting, as well as all other radio services are carried out are equally spaced in frequency. The published mathematical investigations deal exclusively with per cent frequency difference, which has no practical interpretation in terms of actual receiver performance. Even the current statement of selectivity in terms of bandwidth has no physical meaning as an indication of the signals that will be successfully rejected. What we desire to know is not the width of an inverted resonance curve, but just what signal strength, for signals on the channels immediately above and below resonance,

can be tolerated without producing audible interference.

The situation with respect to selectivity can be summarized in a diagram, as is shown in Fig. 1.

This diagram represents the performance of five different types of receivers. The horizontal scale in all four graphs is frequency, and the divisions are the actual channels of broadcasting. Graph A is for a tuned radio-frequency receiver in which straight-line capacity condensers are used. The spacing of the channels on the dial of such a receiver will be as shown, that is, very badly crowded toward the high frequency end. The black curves on this graph represent the apparent width, on the dial, of three signals of equal strength at three different frequencies. Note that, although the actual selectivity of the receiver is much worse at the high frequency end, the *apparent* selectivity is much better at the high frequency end. It shows how completely one fault masked another. It makes clear the fact that the straight line capacity condenser, because it crowded the high frequency channels, completely covered up the glaring fault of the system in which it was used.

Let us now put straight-line-frequency condensers into this receiver. The channels will now be equally spaced on the dial, as in graph B, but the broad tuning at the high frequency end will be strikingly obvious, as indicated by the width of the band covered by the high frequency signal. Such a receiver would meet definite sales resistance because of the lack of apparent selectivity, although the actual selectivity would be the same as in type A, thousands of which were successfully sold. Thus we see the reason the straight-line frequency condenser, otherwise an entirely logical and desirable improvement, was so slow to find its way into broadcast receivers.

If, by some method not yet suggested,

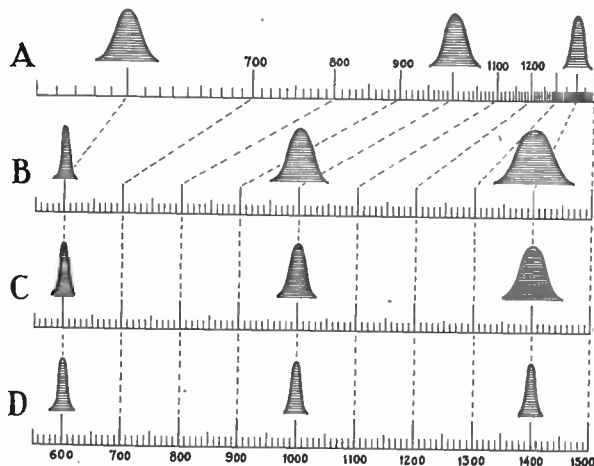

Fig. 1. Selectivity of five types of radio receivers.

†Presented before Radio Club of America, March 9, 1932.  
\*Consulting Engineer.



**Description of a new method of providing variable inductance tuning for radio receivers.**

$$\frac{E_c}{E_s} = \sqrt{K^2 + Q^2(K^2 - 1)^2} \quad K = \frac{\omega}{\omega_0} \quad Q = \frac{\omega_0 L}{R} \quad (1)$$

$$K^2 + Q^2(K^2 - 1)^2 = K^2 + Q^2(K^2 - 1)^2 \quad (2)$$

$$q = \sqrt{a^2 Q^2 + b} \quad a = \frac{(K^2 - 1)^2}{(K^2 - 1)^2} \quad b = \frac{K^2 - K^2}{(K^2 - 1)^2} \quad (3)$$

$$\frac{Q}{q} = \frac{\omega_0 L}{\omega L R} \quad \frac{Q}{q} = 2.73 \quad \frac{\omega_0 L}{R} = 2.73 \frac{\omega L}{R} \quad (4)$$

$$\frac{L}{R} = \frac{L}{R} \quad \frac{L}{R} = 7.43 \quad \frac{L}{R} = 7.43 \quad (5)$$

Fig. 2. Selectivity equations.

we could arrange so that the actual percent selectivity, the selectivity of the mathematical treatments, were constant over the frequency range, we should have the situation shown in graph C. Still the apparent selectivity would be noticeably worse at the high frequency end, and so would be the actual selectivity, so far as ability to reject undesired signals is concerned.

Graph D may be taken as representing a superheterodyne receiver, or a properly designed receiver of the permeability-tuned type. In either case the actual channel selectivity is constant over the range. In the superheterodyne, there would be some slight deviation, depending upon the amount of condenser-tuned-radio-frequency amplification employed. In the permeability-tuned receiver there would be substantially no deviation, and, incidentally, it would not be necessary to employ special mechanical arrangements to secure the equal spacing of the channels on the dial. There can, of course, be no question that the performance of graph D is superior to A, B or C, and that it is the ideal result.

To understand why permeability tuning can accomplish this result, with less tubes and fewer tuned circuits than a superheterodyne, it is necessary to examine the mathematics of the situation.

The usual expression for selectivity is given in equation (1), Fig. 2. This states the ratio of the voltages developed across the tuned circuit by a resonant signal and a non-resonant signal, in terms of K which is the ratio of the two frequencies, and Q which is the ratio of the inductive reactance at resonance to the resistance. Q has been called the figure of merit of the circuit. Note that both K and Q vary with frequency.

In order to determine the conditions for constant selectivity, we use small letters to represent quantities at the low frequency end of the range, and large letters for the high frequency end, and we write equation (2) directly from equation (1). Upon simplification this yields equation (3) which gives, implicitly, the ratio which the values of Q, one at the low frequency end, and

one at the high frequency end, must have for constant selectivity.

Numerical substitution in equation (3) for the broadcast case, and for the actual 10 kc. separation for the broadcast signals, justifies the writing of equation (4) with the assurance that it is correct, at least to a very close order of approximation. Equation (4) gives the important conclusion that for constant selectivity the ratio of inductance to resistance must remain constant.

In normal condenser tuned circuits, and in inductance tuned circuits of the variometer types, the resistance increases approximately as the square of the frequency. Thus Q (equals omega L over R) decreases as the frequency is increased. If R could be made directly proportional to frequency, then Q would be constant, but even then the selectivity would not be constant, because K, the ratio of the frequencies, is also changing. Selectivity, in terms of actual ability to reject signals on undesired channels, can only be constant over the range when the ratio of inductance to resistance does not change.

In condenser tuned circuits, the inductance is held constant and the resistance increases as the square of the frequency. Such a circuit, therefore, cannot have constant selectivity, except by the expedient of artificially increasing the resistance at the low frequency end. A good tuned circuit has a resistance of about 4 ohms at 550 kc. and 30 ohms at 1,500 kc. If we can contrive to keep the resistance up to 30 ohms throughout the range, then we can have constant selectivity over the range, and it will be just as broad as 550 kc. as it now is at 1,500.

In inductance tuning, the inductance must change inversely as the square of the frequency. For constant selectivity, the resistance must also change inversely as the square of the frequency. This is expressed in equation (5) which states that the resistance and the inductance are to be approximately eight times as large at the low frequency end of the range as they are at the high frequency end.

How can we design a variometer, for use in an inductance tuned circuit, such that the inductance and the resistance will increase together, and their ratio

Porcelain	2150 x 10 <sup>12</sup>
Glass	990 x 10 <sup>12</sup>
Bakelite	36 x 10 <sup>12</sup>
Polydoroff iron	50
Carbon (filament)	.004
Nichrome	.000 109
Steel	.000 045 6
Iron (pure)	.000 008 85
Copper	.000 001 589

Fig. 3. Comparative resistivity in ohms per centimeter cube.

remain constant? By a very simple expedient. We will design our circuit at the high frequency end, at 1,500 kc., to have whatever properties we desire to get, high gain and a high order of selectivity. We will use a relatively small inductance and a relatively large fixed condenser. Naturally both of these will have to be designed so as to have low losses.

### Variable Inductance

We will then tune this combination down to 550 kc. by gradually inserting an iron core into the inductance. This will increase both its inductance and its resistance, and we may expect that they will increase together, since both depend upon the amount of iron which is actually inserted in the magnetic field. It will, of course, take a very special form of iron. No form that we have known in the past can be brought anywhere near a tuned radio-frequency circuit without increasing its apparent resistance out of all proportion to the gain in inductance.

Before we examine the material and the core, let us see what some of the other consequences of this method of tuning are going to be. We are not increasing the inductance of the coil itself. What we are doing is to increase the permeability of the surrounding medium. We are actually inserting a new factor in the equation for the frequency of the system. This factor is the effective permeability of the space around the coil. This is the reason for calling the system permeability tuning.

We should assume, from the nature of the method, that if we have two coils of different inductances, but of the same physical dimensions, and if we insert two identical cores into them, the percentage change in inductance would be the same. If we tune these two coils, with different fixed condensers to the same frequency, then as the cores are inserted they should remain in step with each other.

This result can easily be secured, and it has tremendous consequences. It means that for the first time we have a method of tuning the antenna circuit of a broadcast receiver, and keeping it exactly aligned with the other tuned circuits. It means that we can thus secure a gain ahead of the first grid, due to resonance in the antenna circuit, which gives a very noticeable and valuable decrease in the amount of subsequent amplification necessary. But the most important result, so far as the user is concerned, is the marked improvement in the signal-to-noise ratio. This, more than any other feature of the performance of a permeability-tuned receiver, is its outstanding advantage over other present types.

Another result, not quite so obvious, perhaps, is that the frequency to which the system is tuned at any time is almost exactly proportional to the distance to which the core has been removed from the coil. By a slight re-ction in the shape of the core the relation may be made exact, and this gives, without additional mechanical gear, a uniform or "straight-line-frequency" distribution of the channels on the indicator. Thus the result so difficult to secure with condenser tuning is easily and naturally accomplished in the permeability method.

Since the resistance and the inductance increase at the same rate, an oscillator can be built in which the output is very nearly constant. And, by the use of a series inductance, not affected by the core, such an oscillator can be kept at any desired absolute frequency difference from other tuned circuits on the same uni-control system. Such an oscillator would have wide usefulness in superheterodyne receivers.

If it is desired to build a receiver having two or three ranges, each as wide as the present broadcast range, this can be accomplished by using as many taps on the fixed condensers in each tuned circuit. These taps can be selected by a gang switch without appreciable increase in losses, and the arrangement is mechanically convenient and simple. The ranges in such a receiver will not have quite the same performance, but the difference can be minimized by proper choice of the inductance and the capacity steps. Here, therefore, is a new and simple answer to the problem of an "all-wave" receiver for European service, or for any other service requiring an extremely wide range.

In a condenser tuned system there is a certain minimum capacity, represented by the maximum spacing obtainable between the rotor and the stator, and by the various capacities which exist in the circuits. This minimum capacity determines the value of inductance to be used, since the two together must produce resonance at 1,500 kc. The maximum value of the condenser is thus also determined, since this value taken with the same value of inductance must tune to 550 kc.

With permeability tuning, there is no such limitation. The inductance may have any value desirable to produce the required performance. Whatever the value of the inductance may be, it will be increased approximately eight times by the insertion of the core. Whatever the resonant frequency of coil and condenser may be, it will be decreased to approximately one-third this value, when the core goes into the coil. Thus we really have a new, an independent variable. It is not the inductance of

the coil itself that we are varying: it is the effective permeability of the medium surrounding the coil.

When the research to find a form of iron that could be successfully used at radio frequencies was first undertaken, it was appreciated that the task was no small one. In fact, quite a group of scientists had said that it could not be done, and this same statement was repeated after the work was well under way. The core material that we have today is no chance discovery. It is the result of a carefully planned and adequately financed research.

**Core Material**

Iron sulphate is reduced by hydrogen to a metallic powder. The sulphate is rhombic in crystalline form, the iron cubic. In passing from rhombic to cubic the material must go through atomic or at least molecular dimensions. By proper control of the process it is possible to obtain the powdered iron in any desired degree of fineness. Iron dust

so fine that it will float in the air can be produced. The particle size which has been chosen for this use is 10 microns, approximately 0.00039 inch. The powder is, of course, of very high purity.

Before this powder is allowed to come into contact with air, the individual particles are insulated. This requires an entirely new insulator, especially developed for the purpose. None of the existing insulating materials was suited to the work. The film surrounding each particle is approximately one micron thick. This amount of insulation is adequate for the minute voltages generated in the particles by the magnetic field. Current is therefore effectively prevented from flowing between particles. The eddy current loss is therefore limited to the energy that can be dissipated within the particles, and this loss, in particles of the size mentioned, is low enough to permit successful use at the frequencies used in broadcasting.

This insulated iron powder is now molded with bakelite in much the same

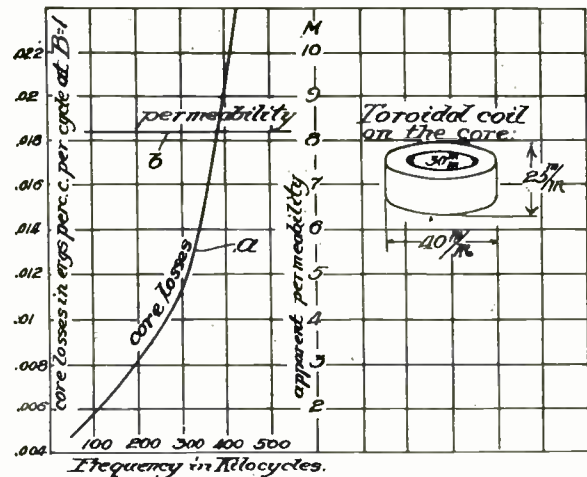
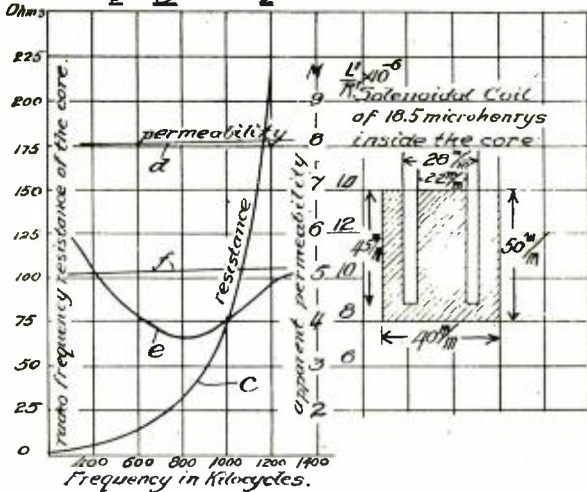

Fig. 4 Characteristics curves.





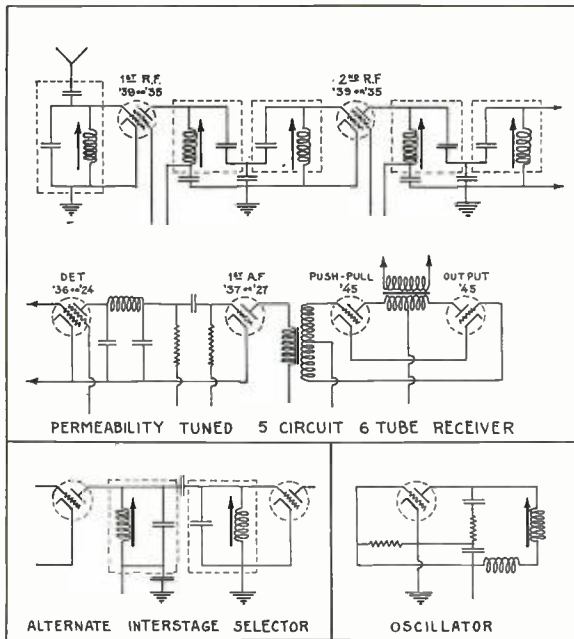

Fig. 7. Condenser coupling of plate and grid circuits.

ning across the back of the unit. The sensitivity of this receiver was better than 1 microvolt, and it would successfully reject a signal 10 times as strong as the desired signal on the adjacent channels.

**Practical Application**

The development since this first receiver was produced has been chiefly in two directions: first, to produce a more effective and less expensive mechanism and, second, to determine the form of circuit best adapted to take full advantage of the unique properties of the new system and the high amplifying capabilities of the later screen grid tubes. As a result of this work, the latest chassis are quite different, both mechanically and electrically, and they are correspondingly better in performance, lower in cost, and more completely adapted to quantity production in a modern factory. Because of the inherent savings of space which result from the method, no attempt has been made to crowd the new designs into the smallest possible compass. There is, therefore, ample room for easy wiring and assembly, and yet the complete chassis is smaller and lighter than any of the current condenser tuned chassis of equivalent performance.

The circuit development has led to the adoption of a condenser coupled arrangement with both plate and grid circuits tuned, as is shown in Fig. 7. The antenna circuit, which directly feeds the grid of the first tube is also tuned so that we have five tuned circuits, but only two radio-frequency amplifier tubes. The antenna circuit is made to

follow the other tuned circuits exactly by initial adjustment of the series antenna condenser and gives a gain on the first grid of from 18 to 22. The value of this preliminary tuning, before any amplification takes place, reducing the value of interfering signals and inductive disturbances before they reach the first grid cannot be over-estimated. That this produces a marked improvement in performance is apparent the moment the receiver is tuned to the first signal.

In all the tuned circuits the inductance value, measured without the core, is 65 microhenrys, and the capacitance is 160 mmfd., which is approximately three times the minimum capacitance, effective at 1,500 kc., in condenser tuned systems. The coupling condensers are .02 mfd. Other constants of the radio

amplifier and the complete audio amplifier are normal.

The symbol used here to indicate variable permeability has simplicity if nothing else to recommend it, and it has been found to be not easily confused with other features usual in radio diagrams.

At the lower left is shown an alternate arrangement for the tuned circuits between the tubes which more nearly corresponds to the forms that have been used with condenser tuning, but, perhaps for that very reason, is not quite so constant in performance over the range. There is also shown, at the bottom right, the circuit for an oscillator, which will have very nearly constant output.

The five tuned circuits are assembled into a mechanical unit illustrated in Fig. 8 actually smaller than the usual five-gang condenser. The cores are mounted on a rigid bridle, actuated by a short rack and a cooperating pinion on the knob shaft. Any reasonable motion reduction can thus be easily secured, and this without complicating the very simple indicator, which can be adapted to either "full-vision" or the more usual type of dial, and is automatically "straight-line-frequency."

In the view at the lower right, some of the shield cans have been removed to show the coils and cores, and the insulating bases that support the mica condensers. The three top wires, with clips, connect to the grids of the two radio tubes and the detector, the black wire to the antenna terminal, and the four remaining wires to the two plates, and to the B supply. The coils are mounted directly on the back plate, not on the porcelain, in such a way that they may be adjusted to give the initial correct position with respect to the cores which are rigidly mounted on the bridle.

Since both the inductance and the capacitance are capable of adjustment,

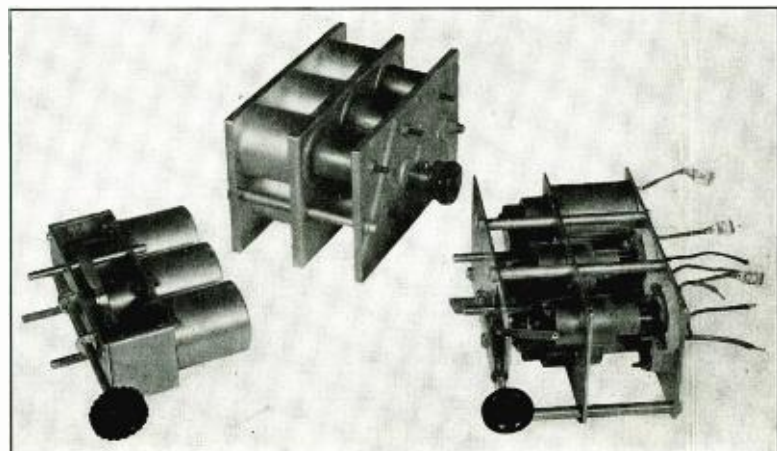

Fig. 8. Assembly of tuning units.

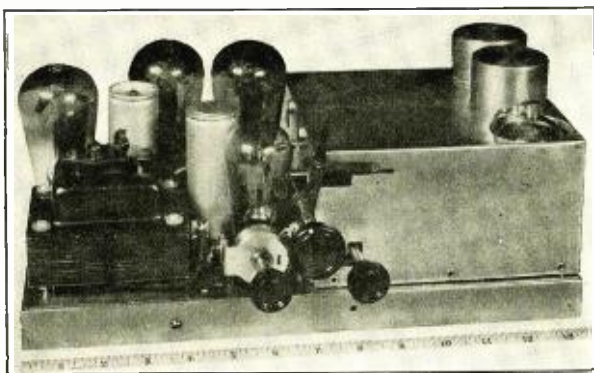

Fig. 9. Completed chassis.

the inductance by the relative position of the core and coil, and the capacitance by the small adjustable leaf on the fixed condenser, the receiver is aligned after it has been completely assembled. There is no step equivalent to the necessity, in condenser-tuned systems, of aligning the gang unit before it is assembled on the set. The only source of variation is the moulded cores, and these are made in the same mould, under the same temperature and pressure, from a weighed quantity of material from a large and thoroughly mixed batch. Careful checks have shown that the degree of reproducibility is very high, and that the maximum error in a five gang unit will be less than one-half of one per cent. There is the further advantage that the maximum error occurs at 550 kc. where the stations have the greatest per cent separation. The method of alignment produces exact agreement at two points in the range. With the cores all the way out, the circuits are definitely tuned to a 1500 kc. signal, by adjustment of the condensers. The cores are then advanced to a mid position, and exact resonance to a 1000 kc. signal is secured by adjustment of the position of the coils with respect to the cores.

The overall alignment is thus actually better than can be secured by the prior calibration of variable condensers and

coils in the usual system, and nothing short of actual tinkering will change it after it has once been established. The effect of changes in temperature is nil, and there are no parts sufficiently delicate to be displaced due to jars received in shipment. Slight differences between the inductance values of the coils are of no consequence, provided the coils are geometrically alike, and this is secured by using moulded forms.

Another form of unit, shown at the center, Fig. 8, is directly adjusted by a screw passing through the bridge. This type may be more adaptable in some applications. There is also shown, at the left, a three core unit intended for possible use as a pretuner in superheterodynes.

In the completed chassis shown in Fig. 9, the units have been so arranged as to bring the three controls out at the center, so that adaptation to any cabinet design would be easy. Other arrangements can of course be made. Because there is no variable condenser gang, and because each tuned circuit is complete in itself, the wiring under the chassis pan is very much simplified. The receiver shown is only an "engineering model" and still requires the attention of the factory or production engineers to eliminate those little difficulties of as-

sembly and wiring which make such a large difference in the speed of production and in the cost. Being almost completely hand made, it does not present the finished appearance of a factory product.

It is a matter of some difficulty to give anything amounting to an accurate cost comparison. The cores themselves will cost no more than the variable condensers which they replace. Beyond this there are a number of direct and indirect savings. The coils, for example, have a very much smaller secondary winding, and no primary. Nor have they any compensating windings. They are smaller in diameter, and so are the shield cans. Thus the space now occupied by the variable condenser gang is completely saved, and the space required for the coils greatly reduced. The high frequency wiring is materially simplified and shortened. Since the tuning and coupling condensers are mounted inside the shield cans, which are magnetically closed by the cores, the shielding is also greatly simplified. Compared to the superheterodynes, the oscillator and its tuned circuit and coupling means are saved. Even if the cores had to be sold at a slight advance over the cost of the variable condenser sections, there would still be a considerable saving.

One factor deserves to be emphasized. Receivers built in accordance with the new method will be strikingly new and different, both in appearance and in performance. The dealer first, and the public later, will be conscious of this difference. And they will conclude that a worthwhile new contribution has been made to the art of radio reception. This is the factor which more than any other recommends permeability tuning to the sales managers and the executive heads of the industry.

To the inventor, Mr. Polydoroff, and to Mr. Victor S. Johnson, who supported him, goes the credit for having successfully completed an important and courageous research addressed to the problem of radio reception.

▲ ▲ ▲

## New Canadian Station

Ground was broken in April in Sandwich, Ontario for the transmitter house for radio station CKWO, which will be the first radio station on the Ontario western side of the border and will start broadcasting May 31st. The towers, which will be 200 feet high and 500 feet apart, will be the highest in the Dominion.

The station will broadcast the best of Canadian programs, as well as features of international interest through its hookup with the Columbia Broadcasting System.

Studios will occupy the twelfth floor of the Guaranty Trust Building in Windsor, with supplementary studios in Detroit.

The Border Cities Star, one of the acknowledged leaders in Canadian newspaperdom, will use the station to broadcast news. The station is owned by Essex Broadcasters, Limited, the directors of which are: Malcolm G. Campbell, president of Kelsey Wheel Company; W. B. Perley, president of Canadian Steel Company; A. F. Healy, president, and C. W. McDiarmid, vice-president, The Guaranty Trust Company, and W. F. Morgan-Deane, retired industrialist.



# Radio dissemination of the national standard of frequency †

By J. H. DELLINGER and E. L. HALL\*

**T**HE fundamental standard in radio communications is that of frequency. In order that the maximum number of radio messages or programs may be transmitted simultaneously, it is necessary that the frequencies of the radio waves which carry them be maintained very accurately. If the frequency varies, the message or program will interfere with others carried on adjacent frequencies. Therefore accurately maintaining frequency is a basic requirement of all radio operation.

Means must be provided to insure that all stations operate accurately on the same frequency basis. Fortunately, the standard of frequency has the unique property that it can be made widely available by means of radio transmission. Radio waves of which the frequency is carefully controlled and accurately known furnish a standard of frequency which is simultaneously available everywhere that the waves can be received.

To meet this need, the Bureau of Standards has provided a standard frequency service regularly for the past nine years. It has transmitted special waves from its own station, on announced frequencies which have been carefully maintained in terms of the national primary standard of frequency kept by the Bureau. The transmissions are at scheduled times announced and published in advance. Their accuracy has at all times been more than adequate for the needs of radio service. These needs have become more and more rigorous, and the accuracy of the Bureau's standards and of the transmissions has progressively increased. The technique of the transmissions has also improved; the waves actually transmitted are held constant to the same accuracy as that of the primary standard itself, upon which the transmissions are based. The accuracy is better than a part in 5 million, and is being steadily improved.

It is the goal of the Bureau to make these transmissions with adequate power and on suitable frequencies to

provide reliable frequency standards at all times everywhere in the United States. The nature of radio wave transmission is such that when this is achieved, a fair service of the same kind will be rendered throughout a large part of the world; and it may be possible eventually to make the service actually reliable and available throughout the whole world. During the present year the transmissions are made every Tuesday for two hours in the afternoon and two hours in the evening. Arrangements have been made to extend this so as to provide the same service every day instead of only one day a week. It is expected that this extended service will be on the air before the end of the year. The program contemplates eventually making the service continuous all day every day. If this goal is achieved a frequency service will then be available at all times and places.

## A New Transmitter

At the present time the transmissions are carried on with a transmitter of one-kilowatt power. In the new transmitter about to be installed this will be increased to 30 kilowatts, which should be adequate. The principal transmissions are on a frequency of 5,000 kilocycles per second. They have been received and utilized satisfactorily, practically everywhere in the United States, including the west coast, Alaska, and Canal Zone. They have also been measured in Italy and England. The frequency mentioned is a satisfactory one for night use. It is expected to use 15,000 as well as 5,000 kilocycles for the daytime transmissions. Other frequencies, such as 10,000, 20,000, and 25,000 may be used if found necessary to cover greater distances reliably. Besides the carrier frequencies mentioned, it is expected to have the transmitted waves carry one or more modulation frequencies. The frequencies tentatively in view are 10,000 cycles per second and 60 cycles per second. The former will have a variety of uses for radio and physical purposes. The use of a 60-cycle modulation is discussed further herein.

The physical equipment for transmitting the standard frequencies and insuring their accuracy is in two major parts, a transmitting station and a monitoring station. The transmitting station is at Beltsville, Md., 12 miles northeast of the main radio laboratory of the Bureau of Standards in Washington, D. C. The monitoring station is in the Bureau's main radio laboratory.

The transmitting set is essentially a harmonic amplifier, successive stages multiplying the frequency up from an input frequency of 200 kilocycles. Symmetrical doublet antennas are used. The input frequency is taken directly from the primary frequency standard of the Bureau; i.e., the national standard of frequency. This is done in either of two ways. The primary frequency standard consists of a group of seven piezo oscillators of special design; five of these piezo oscillators are maintained at the main Bureau laboratory, but two of them are at the transmitting station. All of them are intercompared regularly, and the absolute frequency is measured daily; their means constitutes the primary standard. The transmitter frequency can be controlled by any one of them. When one of the piezo oscillators at the transmitting station is used, its frequency (200 kc.) is applied directly to the transmitter input. When one of those at the main Bureau laboratory is used, its frequency is demultiplied to 10 kc. this frequency is carried over a wire line to the transmitting station, and there multiplied up to 200 kc. and applied to the transmitter input. This method of line control has been made practicable by the development of a quartz plate filter to eliminate line noise.

The transmitter was designed particularly for constancy of frequency. Measurements made continuously at the monitoring station during every transmission show that this has been gratifyingly achieved. With the temporary 1-kilowatt transmitter, in use up to the present, the frequency is held steady throughout the whole of each transmission better than a part in ten million; it is furthermore held accurately on the stated frequency within that amount.

The measurements at the monitoring station (12 miles from the transmitting station) have been showing a characteristic difference between afternoon and evening transmissions. The frequency of the received waves at this distance is quite constant during the evening transmissions, but shows variations of one or two parts in ten million during the afternoon transmissions. At this frequency (5000 kc.) and time of day (2 to 4 p.m.) and distance (12 miles), the received waves evidently consist in considerable part of waves returned from the upper atmosphere which vary slightly in frequency because of Doppler effect

†A paper presented at the I. R. E. Convention, April 8, 1932, Pittsburgh, Penna.

\*Bureau of Standards, Washington, D. C.

in the ionized upper atmosphere.

The received waves are regularly observed by personnel of the army, the navy, the Department of Commerce radio division, and airways division, as well as operators of non-government transmitting stations and radio laboratories. One of the results of the mass of data thus accumulated is its contribution to our knowledge of radio transmission phenomena. We now have data on the reception of 5000 kilocycles at all distances up to 3000 miles, afternoon and night, for more than a year. This will aid greatly in the planning of future transmission schedules. The 5000 kilocycles now used covers the whole United States reasonably well in the evening transmissions, but gives service over only about 600 miles in the afternoon. The latter situation will doubtless be improved when the power is increased to 30 kilowatts, but as already stated the use of a higher frequency, probably 15,000 kc., is expected to provide wholly satisfactory day service. The regular availability of the transmissions for reception measurements, with a view to increasing the knowledge of wave transmission phenomena, is one of the valuable features of the service.

One of the uses of the transmissions is the maintenance of the frequency standards of the radio supervisors of the radio division, Department of Commerce, all on the same frequency basis. All of the offices of that service regularly observe the standard frequency transmissions, and set their standards to agree with them. Thus the radio enforcement service of the country is placed directly on the national frequency basis.

#### Wide Use

The standard frequency transmissions are used for the calibration of frequency standards by radio laboratories, manufacturers, and transmitting stations. Their use by transmitting stations will doubtless increase, thus getting the radio stations of the country more and more on a single frequency basis and minimizing radio station interference. At present this is done by periodic checking of the station frequency standard. In time, when the standard frequency service becomes continuous, direct control of the frequency of many stations will be possible. Even under present conditions, the available service is a substantial aid in the approximate synchronization of broadcast stations, elimination of heterodyne interference, and extension of service area.

The accuracy of the standard frequency transmissions is so good that they serve adequately every purpose of time-difference or time-rate standards as well as frequency standards. They

are specially convenient for this purpose because they give a standard which is available from instant to instant instead of available only by integrating processes over long intervals (as in the case of time-signals). If it is found useful, a special signal can be put on the standard frequency transmission at prearranged times to indicate a specific summation of a number of cycles, thus facilitating the use of the transmissions as time-duration signals. Jewelers and persons engaged in physical measurements, geodetic, seismological, and similar work, can by the use of simple receiving equipment, receive the signals and utilize them, by means of chronographs, etc., for whatever time-rate or time-duration purposes they desire. The accuracy is far superior to that obtainable with chronographs checked by time signals.

Another purpose served by the transmissions is the furnishing of a convenient means of intercomparison of the principal frequency standards and clocks of the world.

Mention has been made of the plan to have the transmitted waves carry certain modulation frequencies. Tentatively, 10,000 and 60 cycles per second are in view. If some other frequency would be useful, as for example for a television synchronizing frequency, it may be added. The 10,000-cycle modulation frequency may be useful as a basis for radio broadcast station standards.

The 60-cycle modulation frequency has two possible applications to electric power company operations. Electric clocks are now operated from power supply systems in which special means are provided at the power station to correct the frequency from time to time so that the departures (of the order of one-half per cent) of frequency from minute to minute shall integrate to zero and keep the time correct over long periods. The means of introducing the correction from time to time would be facilitated by the availability of the highly accurate 60-cycle frequency provided by our transmissions. The other possible application may be the utilization of the frequency as a master control which would determine the rate of a steadily operating control device in turn amplified and serving as a speed regulator of primary power plants. It is not yet known whether this application can be worked out in practice, but it would be very valuable in the interconnecting of power plants in a network. There would be much greater smoothness of operation when sudden shifts of load take place between power plants if all were of identically the same frequency.

In conclusion, the standard frequency transmissions of the Bureau of Standards have a growing value in the per-

fecting of radio technique, they furnish a reliable and accurate basis of determining time rates and intervals, and may be of service in power station operation. The accuracy required is already assured. The reliability and availability of the service is being constantly improved. Good progress is being made toward the ultimate goal of making the service available at all times and places.

#### Acknowledgment

The authors desire to acknowledge the assistance rendered in the development of this project by the many organizations that have cooperated in making measurements, and to the Chesapeake and Potomac Telephone Company, which furnished an experimental line for distant control experiments. Their colleagues in the Bureau of Standards who have been responsible for the success of this work are: L. Mickey and A. D. Martin, development of the transmitting station; V. E. Heaton and E. G. Lapham, development of standard piezo oscillators and monitoring methods; C. G. McIlwraith, A. H. Hodge, and W. D. George, primary standard and line control.



#### SOURCES OF LIGHT FOR TELEVISION

(Concluded from page 16)

Its expected life at 25 ma. d-c. operating current is in excess of 300 hours and at 15 ma. is in excess of 500 hours.

Any coupling arrangement may be used provided that the recommended current ratings are not exceeded.

The characteristics of the Speed crater lamp are as follows:

Cathode spot sizes.....	.015, .020, .030, .040
Ignition voltage (av.)....	170-200 volts d-c.
Operating voltage (av.)....	130 volts d-c.
Extinguishing current (approx.)....	3 ma.
Maximum operating current.....	30 ma.
Recommended operating current..	20-25 ma.
D-c. resistance at 25 ma. (approx.) .....	5,000 ohms
A-c. current necessary for complete modulation approximately	5 ma. less than d-c. operating current.



#### CKWO, WINDSOR, CANADA

The twin towers for radio station CKWO, the Windsor station which will be operated by Essex Broadcasters Ltd., were completed in May. These towers are the highest in Canada, rising 200 feet, and are spaced 500 feet apart.

The first part of the construction work on the station, which in addition to broadcasting the finest Canadian programs will carry features of international interest through a hookup with the Columbia Broadcasting System, is completed on schedule and work is progressing with the building, which will be 53 feet across the front and 40 feet deep.

# Further description, and characteristics of the Wunderlich radio tube

BY FREDERICK E. TERMAN, Sc. D.\*

THE Wunderlich tube can be thought of as a triode to which there has been added a second grid that is wound between the meshes of the usual grid. This tube has been developed for grid leak power detection purposes, and gives full-wave grid rectification in a balanced circuit in which negligible radio-frequency current flows in the plate circuit.

The fundamental circuit for obtaining rectification is shown in Fig. 1a,

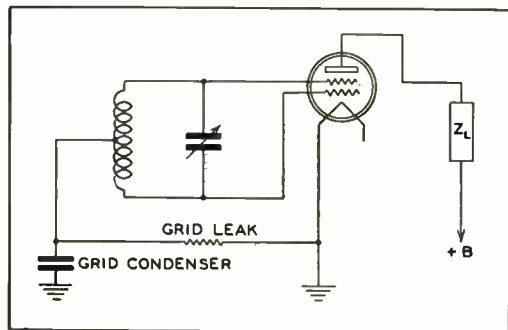

Fig. 1a

and consists in applying for the radio signal between the two grids with a center tap made to the cathode through the grid leak and grid condenser combination. Drawing this input circuit separately as is done in Fig. 1b shows it to be exactly the same as the full-wave center tapped rectifier circuit commonly employed in B supply systems, with the grid-leak condenser combination representing the load impedance to which the rectifier current is delivered. The voltage which the rectified current develops across the leak-condenser combination is applied to the two grids in the same phase, and so is

amplified in the plate circuit by ordinary amplifier action, considering the Wunderlich tube to be a triode in which the grid is formed by the two grids connected in parallel.

When the circuit of Fig. 1 is employed there will be negligible radio-frequency energy flowing in the plate circuit. This is because the radio-frequency voltages applied to the two grids are of equal magnitude but opposite phase, and hence neutralize each other so far as any effect on the plate current is concerned. This balanced input feature has two very important advantages. In the first place, it approximately doubles the available output voltage by eliminating all possibility of simultaneous plate and grid rectification<sup>1</sup>, and in the second place, it makes unnecessary the usual radio-frequency filter in the plate circuit of the detector.

Tests show that the rectified grid current in the Wunderlich tube is largely independent of the plate potential. This, coupled with the fact that the balanced input circuit prevents plate rectification, makes it possible to consider the rectifying and amplifying functions of the tube quite independently of each other. The analysis of the operation of the tube hence involves two distinct and independent steps which are: first, the determination of voltage which the rectifying action in the input circuit develops across the grid leak and condenser, and second, the determination of the amplification which this voltage undergoes when applied to the two grids in parallel.

When the grid leak and grid condenser are proper-

ly proportioned the voltage developed across them by the rectified grid current is almost exactly proportional to amplitude of the radio-frequency signal, and hence is a faithful reproduction of the modulation envelope. The voltage across the leak-condenser combination consists of a d-c. component proportional to the carrier amplitude, and an alternating component that varies with the signal modulated upon the carrier. The d-c. component places a negative bias upon the grids, and is of the correct polarity for automatic volume control purposes. The alternating modulation voltage is superimposed on this bias, and is amplified by ordinary amplifier action (considering the two grids to be connected in parallel) to produce the detector output.

The d-c. and a-c. voltages developed across the leak condenser combination as a result of the rectification process can be most conveniently expressed in terms of the efficiency of rectification B. The d-c. bias voltage which the rectification applies to the grids of the detector and which is also available for automatic volume control purposes is then  $BE_0$ , where  $E_0$  is the crest amplitude of the carrier voltage, and B is the ratio of d-c. voltage developed across the grid leak by the signal to the crest amplitude of the carrier wave. Likewise the audio or modulation voltage developed across the leak is  $B'mE_0$ , where m is the degree of modulation and B' is the efficiency with which the modulation of the carrier is rectified.

There are two principal ways of determining the efficiency of rectification. The first consists in applying a known carrier voltage modulated a known degree to the grids, and measuring the resulting d-c. and modulation frequency voltages developed across the grid leak. This method has the advantage of obtaining results under actual working conditions, but at the same time requires a rather extensive experimental setup and careful technique if good accuracy is to be obtained. A simpler method of determining detector efficiency with an accuracy satisfactory for all ordinary design purposes is shown in Fig. 2. Here an unmodulated voltage of any convenient frequency, such as 60 cycles, and of known amplitude, is applied to the detector input and the change in d-c. plate

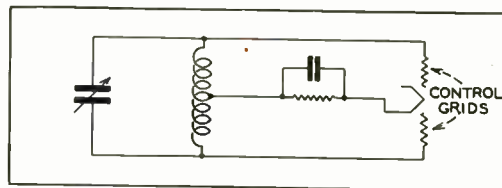

Fig. 1b

\*Professor of Communication Engineering, Stanford University.

<sup>1</sup>For a discussion of the undesirable effects of simultaneous grid and plate rectification in grid-leak power detectors, see F. E. Terman and N. R. Morgan "Some Properties of Grid Leak Power Detection," Proc. I. R. E., vol. 18, p. 2160, Dec., 1930.

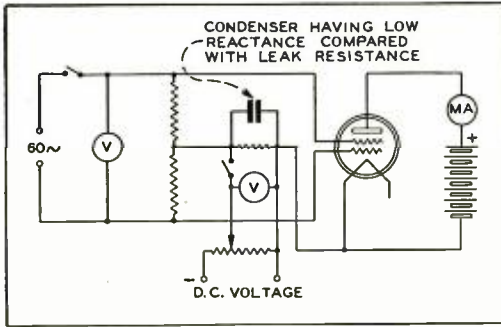

Fig. 2

current noted. The input voltage is then removed, and a d-c. voltage applied to the two grids and adjusted until the d-c. plate current is the same as when the alternating voltage is present. The ratio of d-c. voltage to crest a-c. alternating voltage is the efficiency of rectification B that should be used in calculating the d-c. bias which is placed on the grids by the carrier, while the slope of the curve giving the required d-c. voltage plotted as a function of crest a-c. gives the efficiency of rectification B' used in determining the modulation frequency voltage developed across the grid leak resistance. The results given by the two methods of measurement are in very close agreement when the proportions of grid leak resistance and grid condenser capacity are those required to give distortionless rectification.

Values of rectification efficiency under typical operating conditions are shown in Figs. 3 and 4. The efficiency B giving the relation between d-c. voltage developed across the grid leak and the carrier amplitude is seen to rise rapidly toward 90 per cent or more at signal voltages in the order of several volts, and then to drop slowly with further increases in carrier amplitude, particu-

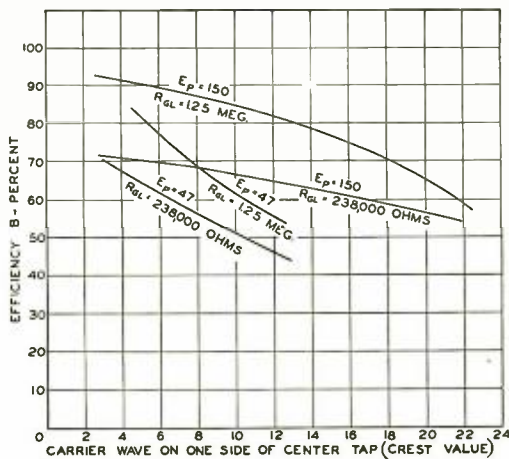

Fig. 3

larly when the plate voltage is low. The efficiency is noticeably higher for the high resistance leak, and for the higher plate voltage. In making estimates of d-c. bias developed across the leak by the carrier wave, reasonably accurate results can be obtained by assuming B to be of the order of 80 to 90 per cent when the signal between grid and center tap is a few volts, and about 60 to 75 per cent when the carrier is in excess of ten volts.

The efficiency of rectification B' that gives the ratio of modulation voltage developed across the grid leak to the modulation voltage contained in the signal envelope is of the same order of magnitude as B for small carrier waves, but becomes somewhat less as the carrier wave becomes large, as the grid leak resistance is lowered, and as the plate voltage becomes less. In general, the value of B' that holds for the Wunderlich tube will range from a maximum of about 90 per cent at small signals to above 40 per cent at the very largest signals, with values in the neighborhood of 50 per cent existing over the most probable operating range.

The detector output should be a faithful reproduction of the modulation envelope of the radio-frequency signal, and in so far as this is not the case, distortion results. This distortion can be divided into two distinct types. The first of these is distortion introduced by the rectification process, as a result of which the alternating voltage developed across the leak-condenser combination fails to be a true replica of the modulation envelope. The second is amplified distortion, and is present when the amplified output of the detector is not an exact reproduction of the voltage which the leak-condenser combination applies to the grids.

The rectification proc-

ess may cause a distorted voltage to be developed across the grid leak as a result of: (1) improper grid leak grid condenser proportions, and (2) variation of rectification efficiency with signal amplitude. Improper leak and condenser proportions makes it impossible for the voltage developed across the leak-condenser combination to follow the variations in the modulation envelope of the signal at high audio frequencies when the degree of modulation is high, and thus introduces a discrimination against the higher frequencies that is also accompanied by an excessive second harmonic distortion. Variation of rectification efficiency with signal amplitude is always present to the extent that the relation between d-c. voltage developed across the grid leak to the amplitude of an unmodu-

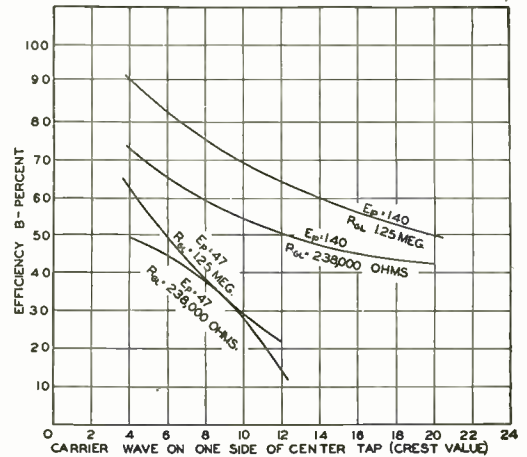

Fig. 4

lated signal, fails to be linear over the range of signal amplitudes represented by the variations in amplitude covered during the modulation cycle. This type of distortion is greatest when the degree of modulation is high, and when the carrier amplitude is small.

The grid leak resistance and grid condenser capacity for use with the Wunderlich detector should be chosen with regard to distortion, rectification efficiency, input resistance to radio frequencies, and the radio-frequency input circuit to the tube. The first and most important requirement is that the voltage across the leak condenser combination be able to follow the variations in the modulation envelopes of the signal. It is shown in the article previously referred to that this consideration will be satisfied if the ratio of X/R satisfies the following equation:

$$\frac{X}{R} > \frac{m}{\sqrt{1-m^2}} \quad (1)$$

where X is the reactance of the effective grid condenser capacity of the tube to

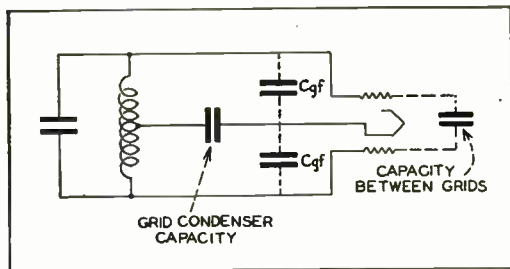

Fig. 5

the audio frequency in question, taking into account the input capacity of the tube;  $R$  is the grid leak resistance, and  $m$  the degree of modulation. It will be observed that distortion becomes more difficult to avoid the larger the grid condenser capacity, the higher the leak resistance, the greater the modulation frequency, and the higher the degree of modulation. In making practical use of (1) it is to be kept in mind that the higher pitched sounds are of relatively low intensity, and so seldom appear with a high degree of modulation. Furthermore, broadcast signals are completely modulated only at occasional peaks of high intensity. Finally, when distortion occurs on the high frequencies, the principle result is to produce second order harmonics which will be suppressed by the audio system and loudspeaker of ordinary radio receivers, and so will not introduce serious consequences. As a result of these factors, it is probable that satisfactory results will be obtained in power grid rectification of broadcast signals if the grid leak and condenser are so proportioned to satisfy (1) at an audio frequency in the order of 3,000 cycles appearing with 50 per cent modulation. The equivalent grid condenser capacity appearing in (1) consists of the input capacity of the tube at audio frequency (taking into account the feedback effect from plate circuit) plus the grid condenser capacity actually placed across the grid leak resistance. The equivalent input capacity of the tube to audio frequency is given approximately by

the following relation:

$$\text{Equivalent input capacity} = C_{gf} + C_{gp} (1+A) \quad (2)$$

where  $A$  is the ratio of output voltage developed between plate and filament, to the input voltage acting on the grids. Under normal conditions this input capacity will be not less than 50 uufds. and may reach 100 uufds. In addition to this tube

capacity, there must be at least 50 uufds. present across the grid leak resistance in order to form an effective radio-frequency circuit from the center tap of the input coil to the cathode. This last capacity can normally be supplied by the stray capacities of the tuning condenser and input coil to ground. The total effective capacity for use in (1) will therefore normally be at least 100 uufds.

With the effective capacity determined by factors that have been outlined, the grid leak resistance is made as high as possible while still satisfying (1). When it is desired to obtain extremely high quality, the leak resistance should be in the order of  $\frac{1}{4}$  megohm, but if a certain amount of distortion is permissible on the modulation peaks and if the audio system is depended upon to suppress harmonics having frequencies above 5000 cycles, grid leak resistances in the order of  $\frac{1}{2}$  to 1 megohm can be employed, and will give higher rectification efficiency and input resistance.

Any grid rectifier consumes energy from the signal as a result of the grid current that flows during the rectification process. It can be readily shown that the total grid loss of the Wunderlich tube is equivalent to shunting a resistance of  $2R_{gk}/B$  between the two grids. This loss is hence of negligible importance unless a grid resistance of less than 100,000 ohms is used.

The equivalent input circuit of the Wunderlich power detector to radio frequencies is shown in Fig. 5. The capacity between the two grids is effectively in parallel with the tuning

capacity, while the center tap connection to the cathode is completed by the grid condenser capacity. In order to obtain an effective center tap connection it is necessary that the grid condenser capacity be considerably larger than grid-cathode capacities  $C_{gf}$  for otherwise the balance in the input circuit will be destroyed.

When the grid condenser and grid leak are proportioned with regard to the considerations that have been outlined above, and the carrier voltage is not too small (i.e. not less than about one volt), the distortion introduced by the rectification process is negligibly small. The distortion varies with the degree of modulation, but with reasonable modulation is small, particularly at carrier amplitude that does not exceed 15 volts crest.

A convenient method of checking

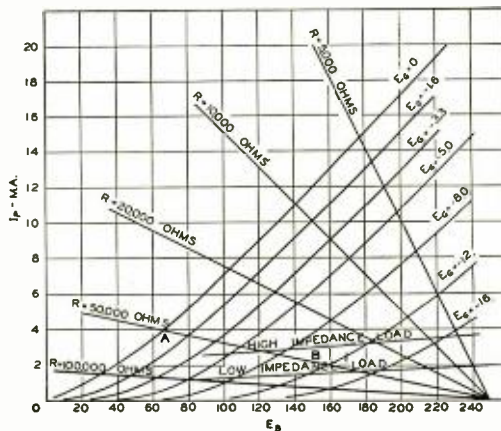

Fig. 6

for distortion in the rectification process is to insert a d-c. microammeter in series with the grid leak and to note whether or not the d-c. rectified grid current varies with the modulation. If the d-c. grid current changes by only a small percentage as the modulation of the signal is put on and taken off, then it is safe to assume that the distortion is small.

The power capacity of the detector is determined by the maximum audio voltage that the tube can amplify without excessive distortion when the two grids are connected in parallel. The characteristics of the tube under these conditions are essentially those of a general purpose triode having an amplification factor of the order of 9 to 12 and a plate resistance ranging between 10,000 and 20,000 ohms, the exact values depending upon the electrode potentials. A set of typical characteristic curves is shown in Fig. 6.

The voltage output obtainable from a triode amplifier without distortion, de-

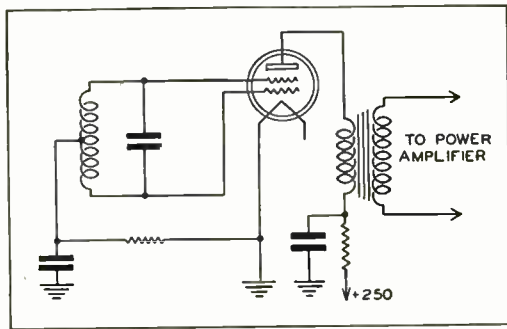

Fig. 7

depends upon the plate potential and the plate load impedance, and as is well understood, is greater the higher the plate voltage and load impedance. The plate voltage that can be applied to the detector is limited by the fact that the grids have zero bias when no signal is impressed on the input. When a high voltage supply is available, such as the 250 volts commonly present in broadcast receivers, the most satisfactory arrangement is to employ either resistance coupling as shown in Fig. 8 or transformer coupling with a series resistance as in Fig. 7. With these arrangements, the resistance in series with the d-c. supply limits the plate current at zero bias. At the same time, when a radio signal places a negative bias on the tube, the resulting reduction in plate current causes the potential actually applied on the plate to exceed the value permissible with no bias, and in this way increases the output voltage obtainable without distortion.

The operating point corresponding to a series resistance R can be located by the graphical construction in Fig. 6, in which a line is drawn through points ( $E_b$ , 0) and (0,  $E_b/R$ ) on the coordinate system, where  $E_b$  is the plate supply voltage. The operating point is then where this line intersects the characteristic curve corresponding to the grid bias actually present. Thus in the 50,000 ohm resistance case the operating point at zero potential is at A, but when a carrier voltage of sufficient amplitude to place a bias of -10 volts on the grid of the tube is present, the operating point shifts to B. It will be observed that the greater the carrier amplitude the more closely will the bias approach the cutoff. The maximum carrier that can be handled is determined by the proper bias for amplifier operation, and this in turn depends upon the load impedance and plate supply voltage, as has been explained. The approximate location of the proper operating conditions for a high load impedance such as employed with resistance coupling, and a moderate load

impedance such as given by transformer coupling, are indicated in Fig. 6. Examination of this figure indicates that the new tube can be operated at grid bias voltages as great as -15 when a 250 volt plate supply is present and a plate current of 10 to 12 ma. is allowable at zero bias. On the assumption of a d-c. rectification efficiency of 70% this means that the largest carrier voltage that can be handled is  $15/0.70=21.3$  volts crest value. When 100% modulated, the crest audio voltage developed across the grid leak by the rectification process would be approximately  $21.3 \times 1.00 \times 0.50=10.65$  volts, and would develop ample amplified output for exciting any pentode or push-pull power amplifier. The exact output depends upon the coupling employed, and can be calculated for any given case by ordinary amplifier theory.

An unbalance between the two sides of the center tap circuit supplying the radio frequency input causes radio frequency current to flow in the plate circuit. This reduces the available power output of the tube, since from the point of view of amplifier action only a certain a-c. voltage can be handled on the grids. If the radio frequency signal voltages applied to the two grids are  $E_1$  and  $E_2$ , then any unbalance between  $E_1$  and  $E_2$  makes it necessary to reduce the audio frequency rectified voltage that can be applied to the tube by  $(E_1-E_2)/2$  volts. It is apparent from this that, reasonably small unbalances have little detrimental effect, since a 20% unbalance reduces the available audio output by only about 10%.

The d-c. voltage developed across the grid leak by the rectified carrier wave can be utilized for automatic volume control purposes. Inasmuch as there is an audio frequency voltage developed across the grid-leak as well as the d-c.

bias, it is necessary to employ some type of filtering to prevent the automatic volume control bias from varying with the modulation of the wave. A simple method for doing this is shown in Fig. 9. The condenser C should have sufficient capacity to be a virtual short circuit to all modulation frequency voltages when compared with the resistance R, but should at the same

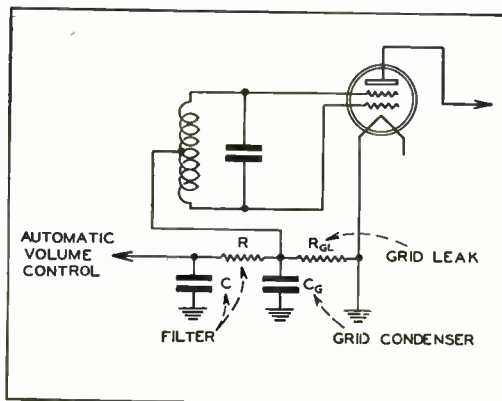

Fig. 9

time have a leakage resistance much higher than R. The resistance R should also be at least several times as great as the grid leak resistance  $R_{GL}$ , if the rectifying efficiency is not to be lowered. The amount of negative d-c. voltage available for automatic volume control depends upon the way in which the plate circuit is arranged, and in the case of the Wunderlich tube can be of the order of 15 volts if desired.

When compared with the plate rectifier commonly employed in broadcast receivers, the Wunderlich detector has the advantage of a somewhat greater rectification efficiency, particularly when the signal voltage is in the order of several volts. The new tube has ample power capacity to excite the power amplifier of any broadcast receiver now on the market, and also supplies a voltage which can be used directly for automatic volume control purposes. When compared with the triode type of grid leak power detector, the Wunderlich power detector has about the same efficiency, introduces less distortion because the balanced input circuit prevents simultaneous grid and plate rectification, and develops approximately twice as much output voltage. The only disadvantage when compared with the corresponding triode rectifier is that the center tapped input circuit requires twice as great a signal voltage for excitation.

### NEW LIGHT FOR PHOTOCELL CIRCUITS

A NEW kind of red electric arc light made with vaporized zinc was shown for the first time April 4, to the Illuminating Engineering Society, at Detroit, Mich.

The lamp was exhibited by Dr. Harvey C. Rentschler, director of research of the Westinghouse Lamp Company, who said no rays whatever except red are produced by the zinc.

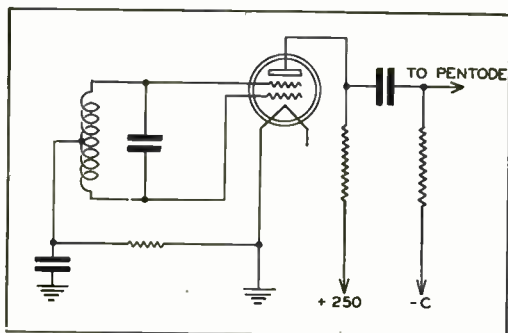

Fig. 8

# Loudspeakers with independent control added to radio receivers

By W. L. PARSONS\*

**T**HE addition of extra speakers to radio sets opens further profitable business to the serviceman and dealer. Any good radio set having adequate output stages of amplification will successfully operate one or more additional speakers. Very satisfactory results can be obtained by the selection of good speakers and the proper volume control with a close observance to impedance matching that is possible without the aid of special equipment.

Home owners will always be interested in separate speakers in the recreation room, the den, possibly the bedroom or kitchen.

Restaurants, ice cream parlors, lodge rooms, schools and other public places are all potential customers for one or more additional speakers, or for complete sound installations. To make such installations practical, and faithful in reproduction, locate a volume control with each speaker that will adjust its volume from maximum to minimum without affecting the volume of the speaker in the set or other speakers on the same amplifier.

It is well to consider the various types of output push pull, parallel and single —45, —50 and pentode tubes. The output impedance of these various systems is as follows: —45, —50 tubes in push pull 8,000 ohms. Parallel 2,000 ohms. Single 4,000 ohms. Pentodes in push pull 14,000 ohms parallel 3,500 ohms, single 7,000 ohms.

The method of connecting additional speakers is illustrated in Fig. 1 which shows connection for push-pull tubes. Fig. 2 shows connections for parallel or single tubes and Fig. 3 for multiple connection of speakers. Multiple connection of speakers is recommended for

\*Engineer, Central Radio Laboratories.

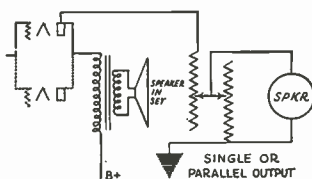

Fig. 1. Push-pull circuit for two loudspeakers.

output systems of push-pull or parallel power tubes. More than one additional speaker is not recommended on single power tube sets.

Magnetic speakers similar to the Western Electric 540 AW and 560 AW having an impedance of 10,000 ohms at 1,000 cycles are excellent for use as additional speakers. The L pad No. 74-544, 10,000 ohms is recommended for multiple installations or the L pad 96-003 for single or group control unit,

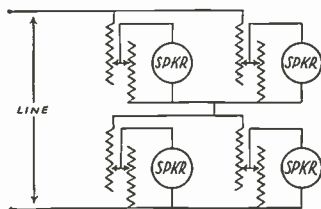

Fig. 2. Parallel or single tube circuit for two loudspeakers.

from amplifiers using 250 tubes in parallel or push-pull.

The arrangement of multiple speakers should have a total impedance equal to or greater, but never less than the output impedance of the amplifier. For example, if two magnetics are paralleled, the total impedance will be half of the impedance of one or 5,000 ohms; if the speakers are connected in series the impedance is doubled or 20,000 ohms. See Fig. 3 for connection whose total impedance is 10,000 ohms. If two speakers are desired on an output system it is better to connect them in series rather than in parallel as the parallel impedance would only be 5,000 ohms and cause a loss in power and a cutoff of the high frequencies. The use of not more than 12 magnetics on push-pull or parallel —50, 8 magnetics for push-pull —45 or pentodes, and one magnetic on single —45 or pentode is recommended. The above recommendations do not apply to public address amplifiers where special output transformers provide accurate matching of impedance values.

Dynamic speakers are usually rated by the manufacturer as having transformers to match tubes in push-pull or

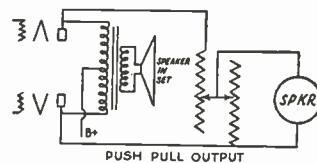

Fig. 3. Multiple connection of loudspeakers.

single —45, —50, or pentodes. It is only necessary to consider a dynamic, with a transformer for push-pull or single —45 or —50 tubes, as proper connections either in series or parallel can be made to match the output systems. If only one speaker is to be added to a push-pull pentode system then it is necessary to obtain a speaker with a transformer for push-pull pentodes.

However, if more than one is to be added a series connection of two dynamics with transformers for push-pull —45 or —50 tubes will have an impedance of 16,000 ohms and will operate satisfactorily.

An L pad for dynamic speakers, transformer for push-pull —45 or —50 in multiple or single is No. 96-003, 10,000 ohms. The No. 96-004, 15,000 ohms, is for use on a dynamic with pentode push-pull transformer.

It must be remembered that we are not considering the use of a regular radio set as a centralized public-address system. Successful operation can only be obtained by religiously adhering to recommended methods. As long as the impedance of the load exceeds or equals the output impedance, and good controls and speakers are used, satisfactory performance will be assured. Many live opportunities lie waiting in this field and properly exploited, will prove profitable.

Although it is not indicated in the diagrams, the insertion of condensers in series with the high potential leads to the speaker lines is advisable. These condensers should be 2mf. capacity 300 volts d-c. of the paper and foil type. The use of condensers in these positions prevents the high d-c. plate potential from being applied to the speaker line, and in the case of a short circuit in the external connections from injuring the radio power supply. In the push-pull circuit a condenser in the lead from each plate is necessary.

## ALLOYS FOR MAGNETIC CORES

The alloy, particularly the iron-nickel-cobalt type, is quenched in water, when molten, and subsequently pulverized. If desired, additions of embrittling materials, ex. iron oxide or iron sulfide, may be added.—International Standard Electric Corp. Appl. (United States) January 31, 1929. Appl. (Germany) September 8, 1929. Issued October 27, 1931.

# Frequency control monitor for broadcast stations

**W**ITH the Federal Radio Commission's General Order No. 116, compelling broadcasters to remain within 50 cycles of their assigned wavelengths, to go into effect June 22, a device has been perfected by which stations can maintain a constant check on their frequencies and consequently correct their transmitters the instant it becomes necessary. The device is a "frequency monitoring" unit, designed for the Western Electric Company by Bell Telephone Laboratories.

The monitoring unit is small and compact, measuring only 12¼ by 13½ by 17 inches. Up to the present, more elaborate equipment has been needed to test the frequencies of transmitters. Most stations have been having periodic tests made by laboratories where such equipment is available. Now the Radio Commission order will not only compel strict adherence to assigned frequencies, but also require that stations themselves have a method of checking their frequencies.

The monitoring unit can be connected into any stage of the transmitter or used entirely apart from it by means of an antenna. This flexibility is made possible by the fact that the input may

come from either a modulated or unmodulated source without affecting the accuracy of the device.

The impulses from the transmitter are introduced into the monitoring unit, passed through a stage of amplification and into a detector tube. The unit contains a quartz crystal oscillator which oscillates at the assigned carrier frequency. The output from this oscillator is also passed through a stage of amplification and fed into the same detector. The output of the detector contains the beat note or difference frequency. This difference frequency is registered on a visual indicator kept un-

der observation by the station's technician.

A self-restoring button mounted on the front of the panel permits a small temporary displacement of the frequency of the monitoring oscillator. From this the operator sees on the same indicator whether the deviation shown is high or low with respect to that of the monitoring equipment.

Complete power supply for the vacuum tubes and crystal heater is included in the unit. The unit is entirely a-c. operated and the power source may be either the 110 or 220 volt, 50 to 60 cycle a-c. supply. The only power connection necessary to set the unit in operation is by cord and plug to the commercial power source.

In addition to being used directly on the transmitter under test, the monitoring unit may be connected to ordinary radio receiving sets, except those of the superheterodyne type. This makes it possible for a station executive, for example, to keep his transmitter under observation by attaching the unit to a radio receiver in his home or office.

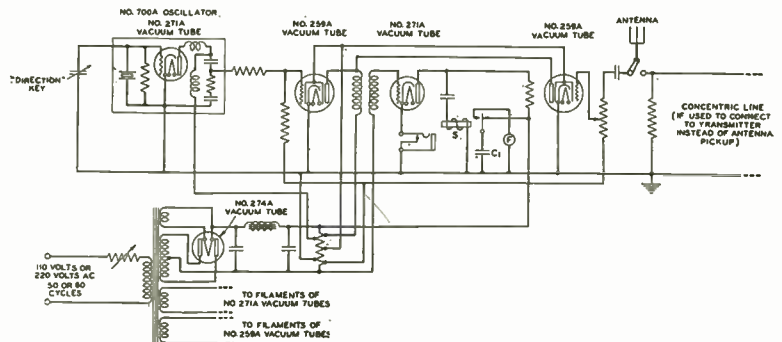

Wiring of monitoring unit.

## Airways radio

**T**HE operator of Station WUCG, the radio station in United Air Lines' hangar at the Chicago municipal airport, is a busy man.

A tri-motored Boeing air liner with passengers and mail had just taken off for San Francisco and the operator sent the dispatch.

While he listened, the message was repeated in sequence by operators at Iowa City, Des Moines, Omaha, Lincoln and North Platte, airports along the plane's route. The operator at Cheyenne, the last station in that division of the California-bound plane, heard the message and sent an "O. K., it's clear," skipping back from station to station, to the Chicago headphones.

The relayed message and its answer on this 1,000-mile span takes only one

and one-half minutes. Thirty seconds after the reply the operator is busy talking to an air liner half way between Cleveland and Chicago. In another minute he hears the report of a plane just out of Dallas, Tex., Chicago bound with passengers and mail.

The dispatch message sent out by the operator ahead of the United Air liner was "WUCG Chicago Morgan hello Iowa City 1 19 Knight Ferguson Zwickey 230 out 4:30 890 1 Cheyenne 2 Salt Lake 1 Reno 6 San Francisco 13 scheduled night. Reserved en route 2 Salt Lake Los Angeles. Chicago."

The message he conveyed was:

"This is United Air Lines station WUCG at Chicago, operator Morgan; hello, Iowa City. Trip No. 1 of the 19th with Knight piloting, Ferguson co-

pilot, and Zwickey, the stewardess, took off in plane No. 230 at 4:30 P. M. with 890 pounds of mail and one passenger for Cheyenne, two for Salt Lake City, one for Reno, six for San Francisco. Knight will radio on night schedule No. 13. Two seats are reserved at Salt Lake City through to Los Angeles. Chicago station signing off."

Every twenty-four hours WUCG maintains its reputation as the busiest airway radio station by following twenty-four mail and passenger planes on the Chicago-New York, Chicago-Dallas and Chicago-Pacific Coast routes with weather reports every twenty minutes. Every hour the United operators speak to thirty-five ground stations in nineteen states.

Thus, a new service progresses.



# Progress in radio tubes

It is fortunate that early in the radio business tube socket and pin dimensions and spacings were standardized. It is fortunate also that the very important improvements which have been made in radio tubes during the past few years have been possible without requiring considerable alterations of space needs. If tubes of improved characteristics had to be twice as large as the types replaced, or of radically different shapes, there would be no end of protest and confusion in the receiver manufacturing industry. Thus the electrical advantages of new types of tubes may be applied without accompanying mechanical difficulties.

### New R-F. Oscillator and A-F. Amplifier Tube

A new 50-watt transmitter tube, r-f. oscillator and a-f. amplifier (Type E703-A) is announced by the Arcturus Radio Tube Co., Newark, N. J. In this tube the unitary structure principle of locking the elements maintains the precise interrelation of parts through interdependence. Each rugged element is securely clamped at the top and bottom and the complete assembly is a sturdy unit—insuring constant uniformity.

This compact unit is supported by a rugged rectangular (4-point) structure instead of by the weaker linear (2-point) principle used in other transmitter tubes.

The increased area of the plate provides generous heat dissipation resulting in cooler operating temperatures.

### RATED CHARACTERISTICS

Filament voltage.....	10 volts
Filament current.....	3.25 amperes
*Plate current.....	72 milliamperes
*Plate resistance.....	5000 ohms
*Transconductance.....	5000 micromhos
Amplification factor.....	25
Plate to grid capacitance.....	15 $\mu\mu\text{f.}$
Input capacitance.....	8 $\mu\mu\text{f.}$
Output capacitance.....	7 $\mu\mu\text{f.}$

<b>Oscillator and R-F. Amplifier</b>	<b>A-F. Power Amplifier</b>
--	---------------------------------

Max. operating plate voltage (d-c.).....	1250 volts
Modulated d-c. plate voltage.....	1000 volts
Non-modulated d-c. plate voltage.....	1250 volts
A-C. plate voltage (r.m.s.).....	1500 volts
Plate current (d-c.).....	175 ma.
Max. plate dissipation.....	100 watts
Plate dissipation.....	*72 watts
Max. r-f. grid current.....	7.5 amps.
Peak grid swing.....	25 volts
Load impedance.....	*9000 ohms
Undistorted power output.....	*5 watts

\*At 1000 volts plate potential and —25 volts grid bias.  
Note: The values of grid voltage given above refer to the mid-point of the filament.

### New Speed Tubes

The Cable Radio Tube Corp., Brooklyn, N. Y., has introduced three new Speed tubes, engineered by A. E. Lyle.

Tense economic conditions in a highly competitive industry have given marked impetus to radio tube development. Many new special-purpose tubes of increased efficiency have already been introduced, and as many more are nearing completion in tube laboratories.

With the introduction of this new line of Speed a-c. tubes (quick heaters), there is now made available to set designers a series of small, extremely efficient, cathode type, detector-amplifier tubes, destined to be widely popular in 1932 radio receivers.

These new 2½ volt tubes are all in smaller size bulbs, and the series comprises the following:

256: An a-c. general-purpose tube (five prong base) similar to Type 227, with improved characteristics; 257: An a-c. radio-frequency pentode, with a six prong base, intended to replace Type 224 in new equipment; 258: An a-c. variable mu radio-frequency pentode with six prong base, intended to replace Type 235 and Type 551 in new equipment.

### CHARACTERISTICS

	Type 256	Type 257	Type 258
Filament potential—volts..	2.5	2.5	2.5
Filament current—amp....	1.0	1.0	1.0
Plate potential—volts.....	250	250	250
Screen potential—volts....	—	100	100
Control grid potential—volts.....	—13.5	—3	—3
Plate current—ma.....	5.0	2.0	8.2
Screen current — ma. (nominal).....	—	1.0	3.0
Plate impedance—ohms... 9,500	1,500,000	800,000	
Amplification factor.....	13.8	1,500	1,280
Mutual conductance — Micromhos.....	1,450	1,225	1,600
At-40 volt grid bias— Micromhos.....	—	—	10
At-50 volt grid bias— Micromhos.....	—	—	2
Bulb.....	S12	S.T. 12	S.T. 12
Base.....	Small	Small	Small
Overall height.....	5 prong 4¾"	6 prong 4¾"	6 prong 4¾"

### Super-Control Amplifier Tube

The Hygrade-Sylvania Corporation, Emporium, Pa., has introduced a new amplifier detector, and a super-control amplifier tube, provided with a suppressor grid and mounted in smaller bulbs than the 224 and 235 tubes.

The filament rating of these tubes has been decreased to one ampere at 2.5 volts. Despite the decreased size and decreased filament rating, these tubes are said to be superior to the 224 and 235, respectively. The new tubes are numbered S-57 and S-58, respectively.

The 56 is a general purpose tube designed as a companion tube to the 57 and 58. These tubes employ heaters requiring one ampere at 2.5 volts. The 56 is mounted in an S-12 bulb and is the same size as the automobile series of tubes, SY-237, etc. This tube may be used to advantage in resistance coupled amplifiers because of the increased amplification factor.

The heater is intended for operation at 2.5 volts. The transformer winding supplying the heater should be designed to deliver 2.5 volts to the heater terminals when rated voltage is applied to the primary.

The heater circuit wiring and heater contacts of the socket should have adequate current carrying capacity in order to minimize circuit drop and contact resistance.

The base of the 56 is of the small 5-pin type, and fits any standard "Y" socket. The tube may be operated vertically or horizontally.

The cathode connection should be returned to the mid-tap of the heater supply winding or to a center-tapped resistor across that winding. If this cannot conveniently be done, it is permissible to bias the heater negative with respect to the

cathode by not more than 45 volts. If the cathode is not connected directly to the heater in a-c. receivers, attention should be given to keeping the circuit impedance between these elements as low as possible. Unless this is done, hum may arise due to heater-cathode leakage.

### Application

As an amplifier, the 56 is applicable either to radio-frequency or audio-frequency circuits. For circuits utilizing resistance coupling, typical operating conditions are as follows:

### Driver Stage

Heater voltage.....	2.5 volts
Plate supply voltage..	250 volts
Grid voltage.....	—9 volts approx.
Plate load.....	30,000-100,000 ohms
Plate current.....	1-2 milliamperes

A grid coupling resistor in excess of 1.0 megohm should not be used.

The 56 is also useful in the driver stage (Class A amplifier) of a Class B power amplifier. For this type of service, the following operating conditions are suggested:

### Driver Stage

	Single 56	Push-pull 56's
Heater voltage.....	2.5	2.5 Volts
Plate voltage.....	250	250 Volts
Grid voltage.....	—13.5	—13.5 Volts
Plate load.....	21,000	16,000* Ohms

\*Plate to plate load.

As a detector, the 56 may be used as a biased detector or as a grid-leak detector. In general, grid-leak detection is the more sensitive, but grid-bias detection permits the handling of greater volume with high quality. For biased detector service, the grid bias may conveniently be obtained from the voltage drop in a resistor between cathode and ground. The value of this self-biasing resistor is not critical, 100,000 to 150,000 ohms being suitable. The higher value will permit the application of a larger input signal.

The 56 may be employed as a two-electrode detector preferably by connecting the plate to the cathode for the one electrode and using the grid for the other. With this arrangement, a-c. input voltages as high as 40 volts r.m.s. may be applied between grid and cathode.

As an oscillator, the 56 may be operated with a plate voltage of approximately 90 volts and zero grid bias. A lower value of plate voltage may be found desirable in some applications.

The 57 and 58 triple grid tubes employ heaters requiring one ampere at 2.5 volts. The 57 has plate current cutoff characteristics similar to but slightly sharper than the 224, while the 58 has remote cutoff characteristics similar to the 235.

These tubes are provided with the new prong bases. The extra pin is used to bring the "suppressor" grid out separately. These tubes utilize the dome-top bulb and are about the same physical size as the 236. The outer screen has been eliminated and an internal shield in the dome has been substituted.

The 57 is designed primarily for use as a biased detector, and as such is capable of delivering a large audio-frequency output voltage of good quality with a fairly small radio-frequency signal applied to the grid. This tube may also be used as an automatic volume control tube of the bias type.

The 58 is designed to reduce cross-talk and modulation distortion in the radio-frequency and intermediate-frequency amplifier stages over the normal range of received signals. This tube may also be employed as a first detector in superheterodyne receivers where it can assist in controlling volume.

(Concluded on page 32)

These tubes are flexible as to circuit considerations because the suppressor grid may be used to control various characteristics such as selectivity and volume control action.

The suppressor grid employed in the design of these tubes is placed between the screen and the plate and has its own base pin connection. The suppressor may or may not be connected to the cathode terminal, depending upon receiver design requirements.

When these two terminals are connected directly together, the suppressor is effective in eliminating the secondary emission effects which limit the voltage swing permissible in the usual screen-grid tube at low plate voltage, that is, at a plate voltage approximately equal to the screen voltage. The suppressor, therefore, makes possible the efficient operation of this type at a relatively low plate voltage. This may be greater than, equal to, or slightly less than the recommended screen voltage.

**RCA Radiotron—E. T. Cunningham**

The R C A Radiotron Company, Inc., and E. T. Cunningham, Inc. have announced five new types of RCA radiotrons and Cunningham radio tubes, designed as

- RCA-46 and C-46....Class B power amplifier
- RCA-56 and C-56....General purpose triode
- RCA-57 and C-57....Triple-grid amplifier detector
- RCA-58 and C-58....Triple-grid supercontrol amplifier
- RCA-82 and CX-82...Full-wave mercury vapor rectifier

The 46 is designed particularly for service in Class B audio amplifier circuits of a-c. operated receivers. A pair of these tubes in a Class B output stage is capable of supplying economically a reserve of power to meet requirements for an extended volume range. The 46 is constructed so that its two grids may be connected in the circuit to make the tube applicable either to the output or the driver stage of a Class B amplifier.

The 56 is a general purpose triode of the a-c. heater type and is recommended for service as detector, amplifier or oscillator.

The 57 is a triple-grid amplifier detector which makes use of a suppressor and a radically new construction to obtain superior performance capabilities.

The 58 is a triple-grid super-control amplifier similar in construction to the 57, but designed to operate effectively over a large range of signal voltages, either with manual or automatic volume control circuits.

The 82 is designed especially for supplying a-c. receivers with d-c. power of uniform voltage independent of variations in the direct current demand. This feature makes this tube uniquely suitable for use in receivers employing Class B power amplifiers.

The design of the 56, 57, and 58 is characterized by relatively low heater power consumption, small size, and excellent characteristics. Both the 57 and the 58 have the unique feature of having the suppressor lead brought out to its own terminal.

Radio engineers will appreciate the flexible adaptability of these five new types in providing unique opportunities for the development of improved receiver circuits. These new types are recommended for use only in receivers designed for their characteristics.

The dome top bulb makes possible close proximity of the external and internal shields. The close spacing of the two shields makes available a low effective grid-plate capacitance. The form of the external shield-can may be somewhat modified depending upon the receiver design re-

RCA Radiotron, Triple Grid, 57



quirements for minimum grid-plates and output capacitance.

Rating and characteristics of the 57 are as follows:

**GENERAL**

- Heater voltage.... 2.5 volts a-c. or d-c.
- Heater current.... 1.0 ampere
- Direct interelectrode capacitances:
  - Effective grid-plate .....0.010  $\mu\text{f}$  max. (With shield can)
  - Input ..... 5.2  $\mu\text{f}$
  - Output ..... 6.8  $\mu\text{f}$
- Overall length.... 4-19/32 to 4-27/32 ins.
- Max. diameter.... 1-9/16 ins.
- Bulb .....St-12 (dome shape)
- Cap .....Small metal
- Base .....Small 6-pin

**AMPLIFIER (CLASS A)**

Operating conditions and characteristics:

- Heater voltage.... 2.5 volts
- Plate voltage.... 250 volts maximum
- Screen voltage.... 100 volts maximum
- Grid voltage.... -3 volts
- Amplification factor Greater than 1,500
- Plate resistance... Greater than 1.5 megohms

Mutual conductance..... 1.225 micromhos

- Grid voltage for cathode current cutoff ..... 7 volts, approx.
- Plate current.... 2.0 milliamperes
- Screen current.... 1.0 milliampere max.

**DETECTOR**

Operating conditions as biased detector:

- Heater voltage.... 2.5 volts
- Plate voltage.... 250 volts maximum
- Screen voltage.... 100 volts maximum
- Grid voltage.... -6 volts approx.
- Plate load—250,000 ohms or 500 Henry choke shunted by a .25 megohm resistor. For resistance load, plate supply voltage will be voltage at plate plus voltage drop in load caused by specified plate current.
- Plate current—Adjusted to approximately 0.1 milliampere with no a-c. input signal.

The base of the 57 is of the small 6-pin type. Its pins require the use of a standard six-contact socket which may be installed to operate the tube either in a vertical or in a horizontal position. For horizontal operation, the socket should be positioned with its heater pin openings one vertically above the other.

**New Photocell**

The Luxtron Mfg. Co., Inc., 241 Lafayette Street, New York, announces a new, inexpensive photocell which operates a relay without amplification. The Lux-Tron cell ST, and relay type R-1, marketed by this company are said to be efficient and useful.

**Cathode Ray Tubes**

The Globe Television and Phone Corp., Starrett-Lehigh building, New York, is marketing a new line of cathode ray tubes. These range in size from a small unit similar to a —45 power tube to units nine inches in diameter. The prices range from \$7.50 to \$80.00. The characteristics of a five-inch type are:

- Filament voltage, 0.5-1 volt.
- Filament current, 5 amperes.
- Accelerating electrode voltage, 400-1,000 volts.
- Sensitivity, 1.0 mm. per volt, each set of plates.

The sensitivity refers to the distance the electronic stream will be deflected by the indicated voltage change impressed on the plates.

**New Tube for New Receiver**

The McIlvane Patent Corporation, St. Charles, Ill., has been granted U. S. patent No. 1,853,914 covering heater type a-c. tubes. The company also has been granted patent No. 1,851,440 covering a new idea in radio receivers. The tubes used are of the electronic expulsion type in which the cathode may be several inches square of caesium or tungsten film.

This thermionic tube comprises a plate, a grid and a cathode, the latter including terminals and a filamentary structure connected between the terminals and comprising adjacent non-contiguous portions which exhibit opposite electric polarity when the terminals are connected to 110 v., a-c. mains.

**50-Watt Amplifier Tube**

A new 50-watt tube for sound, public address and laboratory work is being marketed by the Wakefield Television and Radio Corp., 27 Hoyt St., Newark, N. J. Its characteristics are:

- Filament voltage..... 10 Volts
- Filament current..... 3.25 Amperes
- \*Plate current ..... 72 Milliamperes
- \*Plate Resistance ..... 2100 Ohms
- \*Transconductance ..... 2380 Micromhos
- Amplification factor ..... 5
- Plate to grid capacitance..... 15 mmf.
- Input capacitance ..... 8 mmf.
- Output capacitance..... 7 mmf.

	A. F. Power Amplifier Class A	Modulator
Maximum operating plate voltage (d-c.)...	1250 Volts	1250 Volts
Maximum plate dissipation .....	75 Watts	75 Watts
*Plate dissipation .....	75 Watts	75 Watts
*Plate current (d-c.)...	75 ma.	75 ma.
*Peak grid swing.....	145 Volts	145 Volts
*Load impedance .....	8000 Ohms	
*Undistorted power output .....	20 Watts	
*Modulation factor ....		.06
*Oscillator input per modulator tube .....		120

\*At 1000 volts plate potential and -150 volts grid bias.

NOTE: The values of grid voltage given above refer to the mid-point of the filament.

This tube is equivalent to, and interchangeable with Navy Type 3945 and Type 545.

## OHIOHM RESISTOR OHM DIAL



Have you received one of these handy, instant color code dials for determining resistance? Yours for the asking.

# *As one manufacturer to Another . . .*

Suppose we swap places for the time being. You manufacture resistors; we'll make receivers.

What quality of resistors would you recommend? Anything short of the best? What kind of sets would we turn out—what amount

of grief could we expect—if we bought parts indiscriminately?

The smallest, most obscure little part in any man's set might be the making or the breaking of public acceptance and dealer good-will.

### OHIOHM SPARK SUPPRESSORS

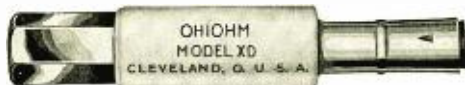

Eliminate ignition interference on automobile radios — a growing market. These suppressors have a non-moisture absorbing glaze, preventing



shorting. Model XD for use in center connection of distributor cap. Model XP for either horizontal or vertical mounting on plug.

# OHIOHMS

*Among the FIRST made resistors—the LATEST in development*

THE OHIO



CARBON CO.

CLEVELAND, OHIO, U. S. A.



**SHORTWAVE AND TELEVISION CORP'N**

A. M. Morgan, general manager of the Shortwave and Television Corporation, advises that the New York offices of the company have been closed and that Walter S. Lemmon, formerly vice-president is no longer connected with the company. The company's offices are at 70 Brookline ave., Boston, Mass.

**TUNG-SOL LAMP REPORTS**

Tung-Sol Lamp Works, Inc., and subsidiary companies, manufacturers of automobile and flashlight bulbs and radio tubes, report net profit in 1931 of \$352,864.92 which is equal to 75 cents per share on the common stock, after deducting dividend of \$3 per share on the preferred. The company's balance sheet as of December 31, 1931 shows an excellent liquid condition, with cash on hand of \$284,149.59 which is in excess of double total current liabilities. Total current assets, including marketable securities and merchandise inventories, amount to \$1,498,844.31 and are more than ten times total current liabilities of \$131,517.58. Reduced selling costs and operating expenses, together with improved production methods, are cited by Harvey W. Harper, president, as responsible for the company's favorable showing in the face of generally adverse conditions in the major industries which absorb its output.

**KOLSTER FORGES AHEAD**

A substantial increase in the working forces in the last month has been added at the factories of Kolster Radio, Inc., at 360 Thomas Street, Newark, N. J.

"In the last month we have added more than 300 employees," announces S. T. Thompson, vice-president of Brandes Products Corporation, the manufacturing subsidiary of Kolster Radio. "We have found this to be necessary in order that our production might keep pace with our sales. The number of workers we now have is sufficient to take care of our production for the next two months. In June we expect that as increased orders are received from dealers in all parts of the country, this force will be materially augmented.

"In the last three weeks we have shipped several thousand sets out of the factory. These sets are all made up on order. They are sold. According to our present plans, we shall keep on the same production schedule for the next eight weeks. Present indications are that in June we shall be obliged to step up our output considerably."

**ANNUAL REPORT OF THE ARCTURUS RADIO TUBE COMPANY**

"Omitting provision for depreciation and amortization of book values," stated President Chester H. Braselton, of The Arcturus Radio Tube Co., Newark, N. J., "the 1931 operations were conducted at a profit. The company practically doubled the number of tubes manufactured and sold during 1931, as compared with 1930, and came within 20 per cent of the quan-

tity sold in 1929, the best year in its experience. Unit prices on radio tubes, however, declined nearly 50 per cent. During the year, Arcturus had no surplus inventories and manufactured only to meet current demands. The increase in sales not only strengthens the company's position, but presages a greater replacement business in 1932, because a large proportion of Arcturus tubes were sold to set manufacturers for initial equipment in new sets.

"Finished inventories were re-priced at the end of the year to conform with lower costs effected in manufacturing. Throughout the year cash was consistently more than sufficient to liquidate all liabilities. No money was borrowed."

**FEDERAL RECEIVES LARGE ORDER**

Mackay Radio and Telegraph Company has placed with the Federal Telegraph Company, of Newark, an order for power supply equipment totaling \$40,000, to increase still further the efficiency of the powerful radio sending station at Sayville, Long Island. It has been especially designed to handle the rapidly increasing volume of messages flowing out of the station. The equipment will be manufactured at the Federal Company's plant at 200 Mount Pleasant Avenue, Newark, N.J.

**DIALS**

The Eddie Mfg. Company, 9 West Illinois St., Chicago, manufactures a line of thirty different types of dials for radio and associated industries. They report business active.

**R.M.A. STANDARD COLOR CODE**

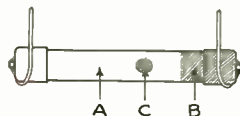

- A—Body color represents first significant figure.
- B—End color represents second significant figure.
- C—Dot color represents the number of ciphers following the first two figures.

A	B	C
Body Color	End Color	Dot Color
0 Black	0 Black	.0 Black
1 Brown	1 Brown	0. Brown
2 Red	2 Red	00. Red
3 Orange	3 Orange	000. Orange
4 Yellow	4 Yellow	0.000. Yellow
5 Green	5 Green	00.000. Green
6 Blue	6 Blue	000.000. Blue
7 Violet	7 Violet	0.000.000. Violet
8 Gray	8 Gray	00.000.000. Gray
9 White	9 White	000.000.000. White

This code is presented by the Aerovox Wireless Corporation, 70-82 Washington Street, Brooklyn, N. Y. This company's 1932 catalogue contains much other valuable data of use to radio engineers.

**CAPEHART GOES RIGHT AHEAD**

"Seventy per cent net increase in business from March over February, 1932—the largest business of the last nine months with the exception of December and its Holiday business."

This is the report of The Capehart Corporation, Fort Wayne, Indiana, pioneer manufacturers of automatic record changing devices and radio-phonograph combinations.

In these days an increase of 70 per cent in business is something to talk about, and in this instance it is particularly impressive in view of the fact that the Capehart products are sold to the most discriminating market of all countries. Considering that the Capehart products are decidedly in the upper price bracket this renewed buying power of the quality market is good news.

The Capehart factory has been in continuous operation from its inception in 1928. The opening months of 1932 find its markets increasing both at home and abroad. Capehart combinations are now being shipped to nearly every country in the world in which there is an appreciation of fine music.

"It is a common mistake," says F. W. Gigax, general manager of The Capehart Corporation, "to consider the quality market only in connection with large incomes. To be sure, most customers are to be found among those of easy circumstances, but these customers after all are only a part of the market.

Recently wide publicity was given to seven sales of Capehart combinations and equipment totaling \$7,267.00 by a Connecticut dealer during the last ninety days of 1931, an average of \$1,038.00 per sale. Needless to say, the dealer's profit on these instruments will be considerably increased by his additional sales of records, etc.

**A NEW RADIO PARTS COMPANY**

Several months ago, a new parts company was formed by executives well known to the radio industry. No announcement was permitted until the factory was equipped and in production. The newcomer is: Solar Manufacturing Corporation, 599 Broadway, New York City. Otto Paschkes, former president of Polymet Manufacturing Corporation, and Paul Hetenyi, until recently, executive vice-president and chief engineer of Polymet, have been the prime-movers in Solar. They have associated with them, a picked personnel from the parts industry.

Solar is specializing in the manufacture of all types of wet and dry electrolytic condensers, and molded mica condensers. Other products will be added to the line as engineering developments are completed.

Messrs. Paschkes and Hetenyi feel the radio industry has needed a new parts company that can operate at minimum cost figures—in line with present-day prices.

Sales are being handled by W. C. Harter, former sales manager of Polymet.

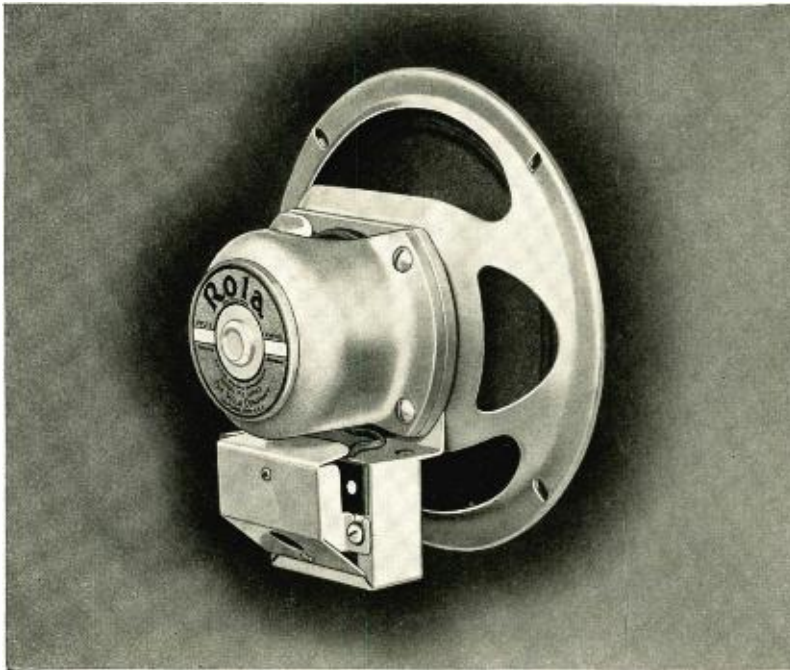

**STANDARD SPECIFICATIONS**

Over-all diameter . . . 6-<sup>5</sup>/<sub>8</sub>"

Over-all depth . . . 3-<sup>9</sup>/<sub>10</sub>"

Effective Cone Diameter 4-<sup>3</sup>/<sub>4</sub>"

Net weight . . 3 lbs. 14 oz.

# ROLA'S NEW MODEL F5

a superior speaker with

## PRE-TESTED PERFORMANCE

Surpassing all previous standards of performance, the new Rola Model F5 speaker is a definite stride forward in loud speaker engineering. Its compact construction, small size and quick installation make it easily the outstanding choice for the small receiver. Skillful engineering and the correct use of raw materials have produced this new Model F5 with greatly increased efficiency at a lower cost. In fact, into every Rola unit goes the ability of experienced loud speaker engineers working with constantly improved facilities—with the very latest of laboratory equipment. In the Rola plant you are never out of sight of the continual

testing processes that produce *pre-tested performance* in every Rola speaker. You cannot afford to take chances on untried makes of speakers when you secure Rola speakers at practically the same price.

Today, as always, Rola is pioneering in new methods, is finding new ways to improve and produce at less cost. The new model F5 is a fore-runner of the changes in our coming year's speakers. Watch for Rola's new developments — a new automobile unit — and others to be announced soon.

Visit the Rola Exhibit at the R. M. A. Trade Show in Chicago, May 23-27. Hotel Stevens Room 539-A. Booth 48 in Exhibition Hall.

# THE ROLA COMPANY

2530 SUPERIOR AVENUE . . . CLEVELAND, OHIO

*Manufacturers of Loud Speaker Units for Midget . . . Automobile and Console Sets  
Also high power Loud Speakers for Public Address Systems and Talking Pictures.*



# Improve your pick-up

... with new  
*Western Electric Moving  
Coil Microphone . . . . .*



With a uniform response throughout the audible frequency range, Western Electric's new moving coil microphone provides clear undistorted pick-up. Features new to high quality microphones, together with rugged simplicity, assure long life, excellent performance and universal adaptability.

Advantages of the Moving Coil Microphone are: (1) Greater flexibility, due to the fact that it may be used at considerable distance from its amplifier. (2) Because of rugged construction and because the amplifier is not housed in the same unit with the microphone, much of the care formerly required in handling pick-up devices is not necessary. (3) Transmission characteristics are not affected by changes in temperature, humidity and barometric pressure. (4) No polarizing energy needed—use of cobalt steel in permanent magnet assures its permanency. (5) Especially desirable for outdoor pick-up, since effect of wind noise has been greatly reduced. (6) Readily adaptable to the present trend toward single microphone pick-up of most studio programs. (7) Developed by Bell Telephone Laboratories—made to Bell standards for sound transmission apparatus. Desk, floor and suspension type mountings are available for this microphone.

## *Western Electric*

RADIO TELEPHONE BROADCASTING EQUIPMENT

Distributed by GRAYBAR Electric Company



*Western Electric 80A Amplifier*

... Designed to transmit effectively frequencies from 35 to 10,000 cycles per second, and to raise the level of the Western Electric moving coil microphone so that it is at least 10 db higher than that of a carbon microphone.

### *Distinctive Features*

Single stage amplifier, employing one new Western Electric No. 262A vacuum tube of extremely low microphonic response.

Designed to operate into either a 200 ohm or 50 ohm circuit.

Plate circuit operates from 200 volt DC or rectified and filtered AC source. Filament circuit operates from 12 volt AC or DC source.

Designed to mount on standard 19" rack—takes only 3½" rack space.

All apparatus and the line terminals on rear of panel protected by dust cover. All wiring and apparatus terminals on front of panel protected by metal mat.

GRAYBAR ELECTRIC CO. R E 5-32  
Graybar Building, New York, N. Y.  
Gentlemen: Please send me full information and booklet on the Western Electric Moving Coil Microphone.

NAME .....  
ADDRESS .....  
CITY ..... STATE .....

## NEW TRADE LITERATURE

The Jefferson Electric Company is distributing a new 8-page folder which illustrates photographically the new plant recently completed, located in Bellwood, a suburb just west of Chicago. The executive, engineering and manufacturing departments (formerly in three plants) are all located in the new building.

## RADIO CATALOG

The Rocke International Electric Corp., 15 Laight St., New York, announces the publication of its new catalogs prepared for the export trade. These are:

1. Radio sets and accessories. 2. Radio parts for manufacturers.

In the radio catalog is featured practically every item that a manufacturer of radio sets or a dealer in radio would be interested in. The items of manufacturers such as the Hammarlund Mfg. Co., Dubilier Condenser Corporation, Allen-Bradley Company, Oxford Products Co., Grove Nameplate & Mfg. Co., etc., are featured.

Only a limited number are available, and those who request these catalogs should give full information to justify the expense involved, as they will not be sent to radio amateurs but only to firms writing in on their own letterheads. Address the Rocke International Electric Corp., 15 Laight St., New York City, mentioning the name of this magazine when requesting these catalogs.

## OHIO ELECTRIC PHILADELPHIA OFFICE

W. G. Ellis, representing The Ohio Electric Mfg. Co., makers of lifting and separation magnets and of fractional size motors has moved his office to 1473 Broad St., Station Bldg., Philadelphia, Pa.

## FRANKLIN RADIO CORPORATION ENTERS FIELD

The reorganized Franklin Radio Corporation and the assets of the Radio Instrument Division of the Van Horne Tube Company of Franklin, Ohio, have just been acquired by the Joyce-Cridland Company of Dayton, Ohio.

The new Franklin Radio Corporation is now located in the modern, spacious plant of its parent company on Linden Avenue, in Dayton, Ohio, and is in production on up-to-the-minute tube checkers, and combination set analyzers and tube checkers, both of which were manufactured in large quantities by its predecessor companies. These instruments are now being manufactured under license agreement with the Weston Electrical Instrument Corporation, Newark, New Jersey.

A complete line of radio service instruments will be announced as quickly as development work can be completed. Other items that will also be announced within the near future include a short wave converter, short wave receiver, short wave transmitter, short wave accessories, automobile radio receiver, and a combination a-c. and d-c. radio receiver for automobile and home use.

The new corporation is headed by A. W. Lloyd, prominently identified with the radio industry since it assumed commercial aspects in 1921. Mr. Lloyd was an official of the Van Horne Tube Company at Franklin during its existence. He has also held important posts with The Crosley Radio Corporation and The Kodak Electric and Manufacturing Company, both of

Cincinnati, and The Leslie F. Muter Company, of Chicago.

The Engineering Department is in charge of J. A. Taylor, Sr., as vice-president, and chief engineer, and J. A. Taylor, Jr., as assistant chief engineer. Both have long been identified with the radio industry, and were active in the engineering and production departments of the Van Horne organization of Franklin. E. J. Munier, secretary and treasurer of The Joyce-Cridland Company is also secretary and treasurer of the new corporation.

## SPOT WELDERS

A new and modern line of spot welders manufactured by the Eisler Electric Corporation, 744-772 South 13th St., Newark, N. J., are described and illustrated in that company's new 24-page catalog. Copies will be forwarded upon request.

## VARIABLE CONDENSERS

United Scientific Laboratories, of 62 West 14th Street, New York City, announce their new line of variable condensers for the 1932-33 season.

This new condenser is designed to meet the commercial requirements of all types of present-day receivers. The manufacturers state that all coupling effects have been eliminated and accurate tuning adjustment of all sections can be easily assured. Another feature is the uniform rotor shaft center line in relation to the side or bottom which permits mounting the condenser in either position without

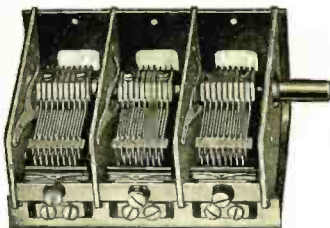

changing the escutcheon cutout on the cabinet panel or the indirect tuning drive dimensions.

The United Scientific Laboratory condenser is available in clock or counter-clockwise rotation with trimmers. The manufacturers will make quotations on one, two or three gang units in capacities from .00015 to .00042 mfd.

## TRANSFORMERS AND CHOKES

The Kenyon Transformer Company, 122-124 Cypress Ave., New York, has issued catalog 11, 112 and 113 which illustrate and describe radio transformers and chokes, transmitting equipment and step-down transformers.

## NEW TELEVISION COMPANY

The Television Enterprises of America has been formed to manufacture and sell a television receiver which, it is said, will show an image 10 inches by 12 inches. The plant of The Television Enterprises of America, at 338 Berry Street, Brooklyn, New York, is equipped and tooled to produce 500 complete televisions per week, and will have models ready for public demonstration at an early date.

The receiver and television was designed by H. Marshall Scolnick, radio and television research and development engineer, who holds the position of chief engineer of the company. The mechanical

design of the television is attributed to Louis Schulman, M. E. The production superintendent is Benjamin May.

## PHONOGRAPH PICKUP AND LOUD-SPEAKER VOLUME CONTROL

The Clarostat Type PH-P5 phonograph pickup and loudspeaker volume control consists of a special taper Clarostat graphite element potentiometer equipped with two tip jacks and cord with phone tips.

It may be connected very easily between the phonograph pickup unit and the radio receiver or amplifier to provide a simple and effective volume control.

It may also be connected between the output of the power stage and a loudspeaker and is especially adapted to control volume at individual loudspeakers when a number of loudspeakers located in different rooms are all fed from the same amplifier.

The stock model Type PH-P5 unit has a 35,000 ohm graphite element potentiometer but other values to suit circuit requirements can be obtained on special order.

The unit is supplied complete with knob.

## AEROVOX CONDENSERS

An announcement from S. I. Cole, of the Aerovox Wireless Corporation, New York, reads:

"The suit brought against us by P. R. Mallory & Co., Incorporated, for infringement of Ruben patents Nos. 1,710,073 and 1,714,191 has been settled.

"We have taken a license under these patents on a royalty basis and have made available to the Mallory Company and only to those others manufacturing under the Ruben patents the right to operate on a royalty basis under our own patents to Georgiev, Nos. 1,789,949 and 1,815,768.

"We believe what we have done is of great advantage to all users of condensers as it eliminates troublesome patent litigation and enables us to devote our attention to the manufacture and sale of condensers which is our business."

## AFFILIATION OF ECHOPHONE AND WESTERN TELEVISION CORP.

A close working agreement between Echophone Radio Mfg. Co., Waukegan, Ill., and Western Television Corp., Chicago, was announced on May 12, in a joint statement by the respective presidents of the two concerns, A. U. Magnan and Clem F. Wade.

The deal involves a substantial purchase of Echophone stock by Western Television, and a change in the latter's manufacturing activities whereby Echophone, in addition to the manufacture of midgets and consoles, will produce Western Television sight receivers. Two pioneer companies are thus linked together.

Echophone has been in continuous operation as a radio manufacturer since 1921. Western Television is one of the largest television companies in the country.

Western Television corporation, according to the announcement, is to devote its entire attention to television research and to the manufacture of television transmitting equipment, such as is used by broadcasting stations, experimenters and amateurs in Illinois, Wisconsin, Indiana, Michigan, Iowa, Missouri, California and Montreal, Canada.

# NEW DEVELOPMENTS OF THE MONTH

## NEW TYPE BINDING-POST USES "PUSH-BUTTON" PRINCIPLE

An entirely new and different binding post has been introduced by the Cinch Manufacturing Corp., Chicago, Ill. By use of the push-button principle, a quicker, and easier connection is provided. At the same time, the Cinch binding post is neat and attractive in appearance—actually a selling feature with no extra cost.

Its use is simplicity itself. Just press the button, insert wire any thickness from



No. 12 to the thinnest size and a firm, perfect contact is established. No threading or wasted motion.

Cinch push button binding posts are completely equipped with soldering lugs with special solder coating—one grounded to chassis, the other ready for wiring.

1-11/16" standard mounting centers. Bakelite 1/16" thick. Push buttons made of moulded Bakelite . . . marked ANT. and GND. respectively.

A number of well-known manufacturers have already made these binding posts standard equipment on their sets, due to both the time-saving and improved appearance features. A sample and complete details will be sent to anyone writing the Cinch Manufacturing Corporation, Chicago, Ill.

## DISTORTION FACTOR METER

Most of the methods of measuring harmonic distortion that have been employed either have been laborious, or have involved elaborate equipment. The type 536-A distortion-factor meter has been developed to enable distortion measurements to be made accurately and rapidly. This instrument has a further important advantage over earlier apparatus in that its input impedance is very high. It may therefore be connected almost anywhere without causing appreciable disturbance of the circuit under test.

In order that these ends might be achieved, two important simplifications of the problem have been made at the outset. Only a single fundamental frequency is employed, and only the total harmonic distortion is measured.

The first of these limitations is not as serious as it at first appears because harmonic production is essentially an amplitude phenomenon. Frequency usually enters into the problem only secondarily. For

this reason a study at a single frequency of the harmonic production in a given piece of apparatus under various operating conditions yields valuable information. The technique of measurement is simplified to such an extent that the required data may be very rapidly obtained.

This instrument is now being marketed by the General Radio Company, 30 State Street, Cambridge, Mass.

## NEW CONDENSERS BY CARDWELL

The Allen D. Cardwell Mfg. Corp., 91 Prospect Street, Brooklyn, N. Y., announce three new condensers which are meeting with favor in various radio applications. These are:

Design 166-B—Type No. S-1683R. Neutralizing or balancing capacity for high power amplifiers.

Maximum capacity . . . . .	35 mmfd.
Minimum capacity . . . . .	19 mmfd.
Plate thickness . . . . .	.375 inch
Airgap between plates . . . . .	.750 inch
Breakdown voltage . . . . .	26,000 v.

Design 166-B—Type No. S-1959R. Double section high voltage vernier capacitor. Has two sections, 3 plates each.

Max. cap. ea. section . . . . .	50 mmfd.
Min. cap. ea. section . . . . .	18 mmfd.

Airgap or number of plates may be varied to suit specified voltage and capacity requirements. Worm drive vernier.

Design 166-B—Type No. S-166BR. Standard for 250 watt equipment.

Maximum capacity . . . . .	297 mmfd.
Minimum capacity . . . . .	38 mmfd.
Airgap between plates . . . . .	.218 inch
No. plates . . . . .	23
Breakdown voltage . . . . .	7,500 volts

## RADIO TUBE CONTAINER



Cross Paper Products Corp., Electrical Division, 2595 Third Ave., New York, manufactures a radio tube container with two outstanding features:

the tube can be tested without removal from the container; and the tube cannot be removed from the container without so destroying a part of the container to make it impossible to replace the tube without it being evident that it had been removed. The latter

feature has been incorporated into the design of the container to safeguard distributors, dealers, and consumers from unscrupulous selling of used tubes on the misrepresentation of their being new. It is said that any one buying a tube in this container can know absolutely that the tube is as it was packed by the manufacturer. The con-

tainer is of such size that the tube cannot be inserted in a set while in the container.

In this container the tube is packed on the suspension principle, and the manufacturer states that the container is of unusual strength, making it possible to subject the tube to rough handling without damage.

## AN EFFICIENT TAPPED CONDENSER

The Octave tone control is now being installed on sample receivers for the coming season. This unit has seven taps giving seven distinct adjustments of tone, eliminating the resistance strip.

The construction is rugged, standing



severe laboratory tests. The capacity remains constant, owing to thorough impregnation with the best waxing compound. The best materials are used throughout, assuring long life.

The Filtermatic Mfg. Co., Hunting Park Ave. and Marshall St., Philadelphia, Pa., are now sending to the trade data and samples as requested.

## TERMINALS AND LUGS

An assortment of approximately 500 terminals and lugs, including battery clips and screen grid caps is now being put out by the F. R. Zierick Mfg. Co., 68 East 131st Street, New York City.

This assortment will be found valuable



for the engineering departments for all radio, television, and electrical concerns.



# Insure auto radio tone quality— maximum selectivity —with the new **PINES** "B"-BATTERY ELIMINATOR

**M**ANY leading radio manufacturers have found it to their advantage to use and recommend the new PINES "B" Battery ELIMINATOR for auto, bus, airplane, motorboat and home radios in place of old-fashioned "B" batteries. It has been proved—by actual test—that it both improves tone quality and makes possible maximum selectivity and distance because it delivers constant, steady voltage.

PINES "B" Battery ELIMINATOR consists of a very efficient motor in combination with a rotary transformer. It receives its current from the regular "A" battery which, through the medium of a rotary transformer, is stepped up to the required high AC voltage, rectified, and filtered through a filter-pack. The result is a smooth, constant DC current to the radio set which produces a clearness of tone never before thought possible in an auto radio.

Made of only the highest quality materials, PINES "B" Battery ELIMINATOR will

give years of service under all conditions. Water, slush or extremes of temperature do not in any way affect its operation or efficiency. It is so simple and rugged that there is nothing to get out of order. Greasing, oiling or adjustments are unnecessary. The PINES "B" Battery ELIMINATOR requires only about one-third the space of the regular "B" batteries. It measures  $5\frac{3}{8} \times 8$  inches and is  $6\frac{1}{4}$  inches deep, weight 15 pounds. It can be very easily installed because it bolts directly to any convenient place under the floor of the car. Requires no cutting.

In actual tests the PINES "B" Battery ELIMINATOR performed perfectly in temperatures as low as 35 degrees below zero Fahrenheit and as high as 150 degrees above zero Fahrenheit. This makes the PINES "B" Battery ELIMINATOR the only "B" power supply not affected by temperature while in service.

If you are not acquainted with the PINES "B" Battery ELIMINATOR, it will pay you

to investigate it fully. Without obligation a PINES engineer will show you how it can improve the performance of your radio sets. Write today.

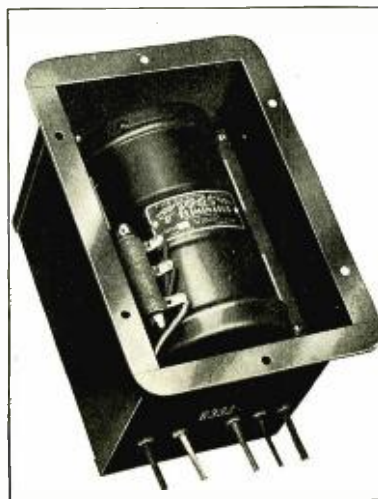

## PINES WINTERFRONT COMPANY

Dept. D, 1157 N. Cicero Ave., Chicago, Ill.

## S.S. WHITE PRODUCTS in RADIO

### • FLEXIBLE SHAFTS • for REMOTE CONTROLS

The No. 150L50 shaft has been developed by S. S. WHITE to meet the special requirements of remote control of radio receivers. This shaft operates with a minimum of torsional deflection and deflection is equal when shaft is rotated in either direction. It provides accurate, sensitive tuning when used with properly designed controls.

Used on PHILCO and other automobile radios, and on STROMBERG-CARLSON and WESTERN ELECTRIC airplane radio receivers.

A new type flexible metallic casing of small outside diameter (.225") has been developed specially for use with the No. 150L50 shaft.

*Descriptive circulars and complete information on request.*

*Cooperative ENGINEERING SERVICE on specific applications is yours for the asking.*

### • MOLDED RESISTORS • for ELECTRONIC EQUIPMENT

Permanent resistance value, great mechanical strength and noiseless operation proved in comparative tests and actual service. Many types and sizes from 1 to 3 watts, with resistances from 2000 ohms to 1,000,000 megohms.

Used in radio receivers, transmitters, condenser microphone amplifiers, resistance coupled amplifiers, public address system amplifiers, traffic signal controls, sensitive electronic hospital and laboratory apparatus, etc. Among the users are: General Electric, Pan American Airways, RCA Communications, Westinghouse, Automatic Signal Corp.

**The S.S. WHITE Dental Mfg. Co., INDUSTRIAL DIVISION**  
152-4 West 42<sup>ND</sup> St. NEW YORK, N.Y.

**OUTLET PLUGS INDIVIDUALLY FUSED**

The Elmenco fused plug, the newest development in attachment plugs, is an improvement that is so obvious that one wonders why it was not made long ago.

This plug, made in both single attachment style and 3-way multiple style, fills the demand for a safe plug.

Its virtue lies in the fact that it is self-

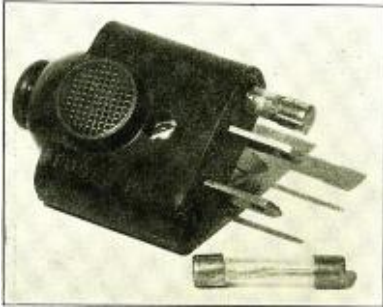

fused. Two small fuses are inserted in the plug, and these fuses prevent any wire trouble getting beyond its point of origin.

It localizes trouble, removes fire hazard and avoids the possibility of all lights out.

When trouble develops, the fuse in the plug will blow, affecting the individual lamp or accessory only.

The main fuses are unaffected, protected by the fused plug.

Fuse elements which have blown are easily removed—simply by pushing them out with a match.

These modern plugs are being marketed by the Electro-Motive Engineering Corporation, 797 East 140th St., New York.

▲

**A RECEIVER FOR PROFESSIONALS**

The Comet Pro. is the name given the new voice and code receiver being marketed by the Hammarlund Mfg. Co., Inc., 424 West 33rd St., New York. The set operates on house current and responds to a frequency range of 20,000 to 1,500 kc. In addition to its use as a service receiver, this set is of real value in research and experimental operations.

▲

**NEW MICROVOLTER—SIGNAL GENERATOR**

The RCA-Victor Company, Inc., Camden, N. J., announce the standard microvolter Type TMV-47-A to fulfill the need for a simple and accurate instrument to be used in the checking and calibration of signal generator equipment. In addition, the standard microvolter may be used as a signal generator provided the voltage required is within its range.

The standard microvolter requires a driving oscillator whose frequency is half the output frequency of the microvolter. This oscillator may either be a signal generator or a simple oscillator, and may be modulated if so desired. Since only the value of r-f. voltage required for the measurement is generated, no errors are introduced from leakage, and the accuracy of the instrument when properly operated over the broadcast band depends upon the accuracy of the d-c. meter used to read the output as no thermocouples are used. The output range is 1-10,000 microvolts.

The equipment is enclosed in a suitable metal case and space is provided inside for plate and bias batteries. Binding posts are

provided for input, output, output meter, and filament battery. Two 36 type tubes six 22½ v. "B" batteries, two 4½ v. bias batteries, and a 6 v. source for the filaments together with a microammeter and a suitable driving oscillator are required for operation.

▲

**RADIO TUBE HANDBOOK**

The Cunningham Radio Tube Handbook contains individual data sheets for each type of Cunningham radio tube. These sheets show not only the main use for which the particular type was designed, but also its rating, operating conditions, characteristics, interelectrode capacitances, base connections, and overall mechanical dimensions. In addition, full sized sheets showing the more commonly used families of static and dynamic characteristics curves have been included for the three, four and five electrode types. Typical output curves for the rectifiers as well as regulation characteristics for the regulator types have been given. All curves have been plotted to easily readable scales and are sufficiently large to be useful for engineering design purposes.

The subscription price for the Handbook including service in keeping it up-to-date for a period of one year is \$3.50.

Anyone desiring a copy of the Handbook may send his remittance directly to E. T. Cunningham, Inc., Commercial Eng. Section, Harrison, N. J.

▲

**A NEW TWO-BUTTON MICROPHONE**

Shure Brothers Company, 337 West Madison St., Chicago, Ill., announce a new two-button microphone that possesses various improved features. The buttons have highly polished gold surfaces. Each unit individually assembled and tested by experts. Supplied with the new "Quick-way" hooks (patent pending) which facilitate mounting in any standard ring or stand. The use of screen in the face of the microphone eliminates the need for covers on the stand. Sturdy binding post nuts permit connections to be made without



the use of tools. Appearance enhanced by modernistic bevel edge. Highly polished and nickel plated.

Model 5N is especially recommended for public address systems in which price is the important factor.

Operates best at 6 to 8 m-c. per button. Limit of guarantee: 10 m-a. per button. Total internal resistance: 400 ohms, or 200 ohms per button. Diameter overall: 3¾ inches. Diameter of frames: 2½ inches. Thickness overall: 1¼ inches. Shipping weight: 1¼ lb. Packed in a strong carton with wiring diagram and complete instructions.

▲

**NEW "B" BATTERY ELIMINATOR**

In addition to manufacturing Winterfronts and other quality products for automobiles, the Pines Winterfront Company recently announced a new auto accessory—the Pines "B" battery eliminator for auto-

bus, motorboat and airplane radios. So successful has this new product been in its ability to improve the tone quality and selectivity of radios that many leading manufacturers are recommending its use with their sets.

Pines "B" battery eliminator is so simple and rugged in its construction that there is nothing to get out of order, nothing to oil or grease, nothing to adjust. It consists of a "triple-tested" motor in connection with a special rotary transformer. It takes the current from the regular "A" battery, steps it up, rectifies and filters it, delivering to the set a constant, smooth d-c. current which produces a clearness of tone heretofore thought impossible in an auto radio.

Before placing the Pines "B" battery eliminator on the market it was subjected to rigid tests. It was found that snow, water or slush in no way affect its efficiency. One of the most severe temperature tests known—a test under temperatures of from 35 degrees below zero to 150 degrees above—failed to impair its performance.

The installation of the new battery eliminator is simple. It requires a space of 5½x8 in., only 6¼ in. deep. This is approximately one-third the space required for the ordinary "B" battery which this eliminator replaces. Its total weight is only fifteen pounds, including a special heavy metal container, which protects it from damage.

Descriptive literature may be had by writing Pines Winterfront Co., 1111 North Cicero Ave., Chicago, Ill.

▲

**NEW LOUDSPEAKER**

RCA Victor Company, Inc., Camden, N. J., announces a new type RL-45 de luxe dynamic loudspeaker for set manufacturers.

This speaker is outstanding for its power handling capabilities and frequency range. It will reproduce without appreciable audible distortion the full undistorted output from two of the new class B, type RCA-46 tubes (20-25 watts).

The mechanical features are the sturdily welded construction of the field structure and the improved voice coil and cone construction. The cone is of treated paper 8" in diameter. The paper manufacturing and corrugating processes have been specially developed to produce a cone having the required overload level and increased range of response. The weight of the speaker less transformer is 18 lbs.

This speaker has been developed for use with the new receivers being brought out that give materially increased frequency response and greatly increased power outputs.

▲

**AN EXPONENTIAL RULE**

L. B. Sklar, 816 North 6th St., Philadelphia, Pa., has introduced a useful exponential slide rule. The rule is a valuable adjunct to an ordinary polyphase slide rule, and aids materially the solution of problems involving roots and powers of numbers less than unity.

▲

**RADIO CONDENSER CO., IN CANADA**

The Radio Condenser Company, Camden, N. J., has established a branch manufacturing plant in Toronto, Canada.

▲

**WIRE STRIPPER**

A wire stripper which removes insulation and twists stranded wire in one operation, is now being marketed by the F. R. Zierick Mfg. Co., 68-72 East 131 Street, New York.

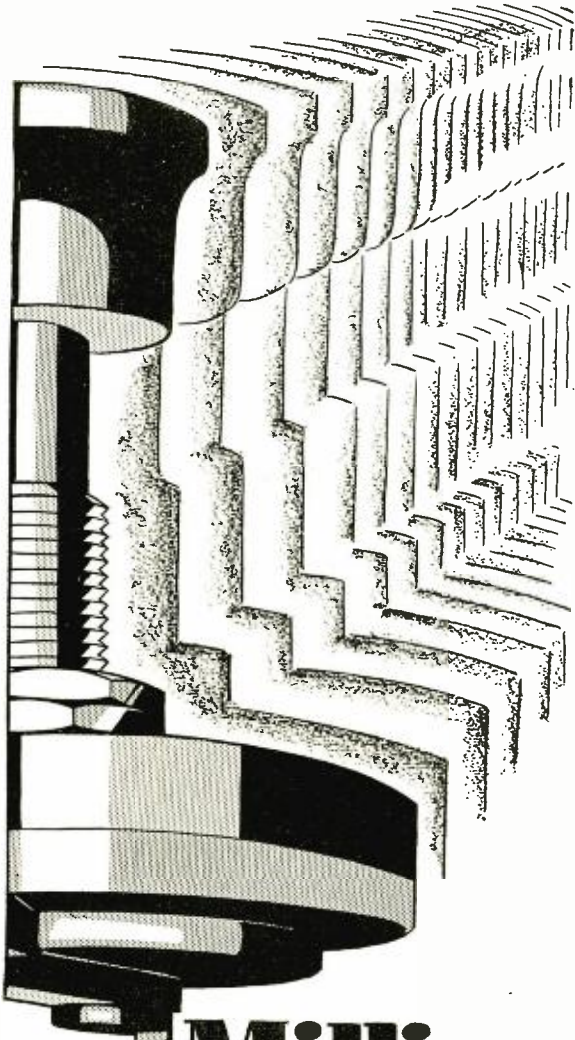

**a Million**  
**CENTRALAB (SWITCH TYPE)**  
**VOLUME CONTROLS**  
**IN 1931**

Centralab by pioneering the self-contained line switch on the Volume Control saved the radio industry thousands of dollars in 1931 and supplied more than a million of that type assembly.

That production volume proves Centralab reliability and assures a still more economical product this year.

CENTRAL RADIO LABORATORIES, MILWAUKEE



**TRANSFORMERS**  
**UP-TO-DATE**

Transformers up-to-date . . . that's the way Thordarson serves the manufacturers of receiving sets. For instance, whenever new tubes are announced—Thordarson is ready with a transformer to meet their characteristics. An intensive and continuous study of your requirements keeps us in step with every new development in the radio field. And our purchasing, production and distribution facilities keep costs low.

Radio manufacturers are invited to consult Thordarson engineers on the adaptation of our transformers to their particular requirements. Let us work with you. The experience of nearly 40 years' leadership in quality transformer production is at your service.

THORDARSON ELECTRIC MFG. COMPANY  
 500 WEST HURON STREET, CHICAGO, ILL.



**STANDARD SINCE 1910**

*Dubilier*  
announces-

**ADVANCED ENGINEERING**

Fresh blood, fresh ideas, fresh enthusiasm have been added to unparalleled Dubilier experience. Electrochemists have developed advanced types of electrolytic condensers. Transmitting specialists are concentrating on high-voltage and ultra-high-frequency capacitors. Dubilier engineering was never more efficient.

**ADVANCED PRODUCTION**

Dubilier laboratory results are being translated into good products at lowest prices in the largest plant devoted exclusively to condensers. New equipment, unique processes, improved methods, critical inspection and efficient management assure better values than ever.

**ADVANCED FEATURES**

For the past six months the Dubilier staff has studied, refined and put into production improved types of capacitors for every purpose. Type for type, you will find outstanding features in every Dubilier unit. For instance:

**ELECTROLYTIC:** Minimum leakage, fastest re-forming time, most efficient power factor, highest working voltage, longest life, due to exclusive process for forming anode foil coating. Let comparative tests tell the story!

**PAPER:** Highest grade tissues PLUS latest impregnation processes make for ample safety factors at lowest prices. The new tubular cartridge units meet present demand for quality at a price.

**MICA:** A complete line of molded mica capacitors for receiving and transmitting purposes now available. Highest safety factor, low radio-frequency losses, attractive appearance and surprisingly moderate price, are at once apparent.

**HIGH FREQUENCY:** Radically new design and special dielectrics meet latest ultra-short-wave transmitting requirements, as well as highest working voltages.

**INDUSTRIAL:** Unique oil-filled standard unit capacitors for assembly in any desired combination best meet requirements of capacitor motor manufacturers and power factor correction problems.

WRITE! *The story is too long to be told here. So why not write for our literature covering any types of condensers in which you are particularly interested. And do not hesitate to place your condenser problems before our engineering staff.*



**DUBILIER  
CONDENSER CORPORATION**

4377 Bronx Boulevard

New York City

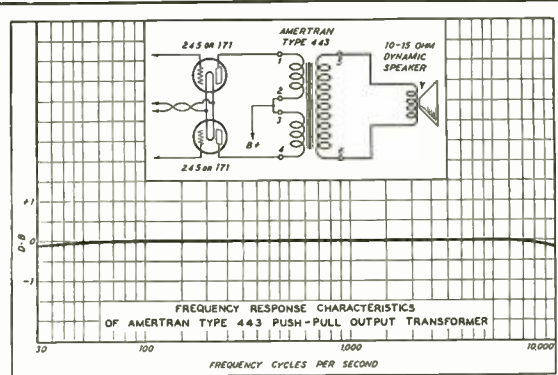

# Output Transformers

With a frequency variation of less than one-quarter DB\* over a range of 30 to 10,000 cycles, Type 443 Push-Pull Output Transformer demonstrates AmerTran's claim—"The closest approach to the ideal that engineering genius can provide."

The above graph is one of a series giving technical data on standard types of AmerTran Audio Transformers. This curve was made with the most accurate measuring equipment available on a standard Type 443 Output Transformer taken from stock—it is typical of frequency-response characteristics of all AmerTran Output Transformers.

\*Engineers agree that a frequency variation of less than 2 DB cannot be detected by the average ear in reproduction of music.

On request we will send you graphs giving similar curves on the following types of AmerTran Transformers—

- Input Transformers
- Interstage Transformers
- Impedance-Matching Transformers
- Mixer Transformers

AMERICAN TRANSFORMER COMPANY  
180 Emmet Street Newark, N. J.



# AMERTRAN AUDIO TRANSFORMERS

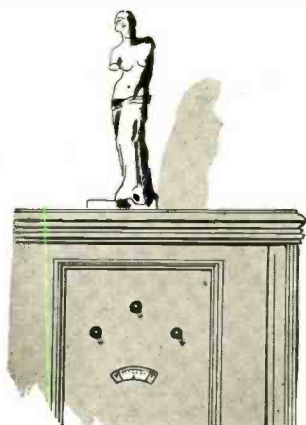

# A SOLID BASE FOR BEAUTY



for  
**CABINET FINISHING**

**SANDING SEALER #5959** was created to fill an important requisite in cabinet finish. Beauty in woodwork surface depends on "the base," and #5959 has a high percentage of solids to make a perfect foundation.

Smooth flowing, it builds and spreads evenly. It is easily sanded and most adaptable of all pyroxylin sealers on the market.

A demonstration is worth a volume of explanation about #5959. Call on our local representative who is a furniture specialist and let him convince you.

*"The Standard of Quality Since 1884"*

## THE ZAPON COMPANY

A Subsidiary of Atlas Powder Company

Stamford



Connecticut



# P.E. CELLS

DeVry Photo Electric Cells, designed primarily for motion picture work, possess a degree of sensitivity and an ionization point far in excess of any other cell now in use. Developed by a special process and protected by patents held by the McIlvaine Patent Corporation, these cells are engineered to give the maximum response even to limited volumes of light.

### Characteristics of the DeVry Photo Electric Cell

The DeVry Photo Electric Cell ionizes at from 130 to 180 volts, which accounts in part for its extraordinary life. At an average operating voltage of 90, these cells have a sensitivity of approximately 75 micro amperes per lumen, and operated at 10 points below the minimum ionization point they possess a sensitivity of approximately 140 micro amperes per lumen. These cells are made in a wide variety of styles to fit any application, and can be had both in argon and vacuum type.

**HERMAN A. DeVRY, Inc.**  
55 E. Wacker Drive  
Dept. R  
CHICAGO, ILL.

### FREE BULLETIN

HERMAN A. DeVRY, INC., 55 E. Wacker Drive, Dept. R, Chicago, Illinois.

Please send me free bulletin containing complete characteristic curves, dimension chart, etc., on DeVry Photo Electric Cells.

Name .....

Address .....

Town ..... State .....

# • FOIL •

TIN

LEAD

ALUMINUM

FOR CONDENSERS

43 YEARS MANUFACTURING  
EXPERIENCE IS YOUR  
GUARANTEE OF QUALITY  
MATERIAL AND  
SATISFACTORY SERVICE

STANDARD WIDTHS IN STOCK  
FOR PROMPT SHIPMENT

**The Johnston Tin Foil & Metal Co.**

DEPT. RC 10  
6016-6160 S. BROADWAY  
ST. LOUIS, MO.

EST. 1889

EASTERN OFFICE  
AND WAREHOUSE  
1224 HALSEY ST.  
BROOKLYN, N. Y.

F. W. FLAD  
Representative  
Tel. JE 1549

# RESINOX

FOR DEPENDABLE  
DIELECTRIC  
STRENGTH

● When you specify "Molded from Resinox" on your purchase order, you are assured of perfectly molded parts, of lustrous beauty, free from surface blemishes, strong and durable, and of dependable dielectric quality.

## RESINOX CORPORATION

A SUBSIDIARY OF COMMERCIAL SOLVENTS CORPORATION  
AND CORN PRODUCTS REFINING CO.  
230 PARK AVENUE NEW YORK CITY

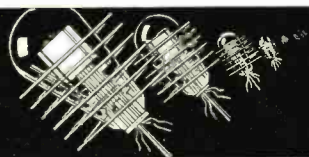

## BOMBARDING

Equipment capable of  
meeting all demands.

Fixtures and bombarding coils  
for special applications.

### High Frequency Furnaces

Designers and builders of  
high frequency converters  
for over 20 years.

# LEPEL

HIGH FREQUENCY LAB., INC.

39 WEST 60th STREET NEW YORK



MAGNET WIRE (Cotton or Silk).  
STRAND—Antennae (plain or  
enameled), Double Galvanized. WIRE  
Antennae (plain or enameled); Con-  
necting and Ground (Rubber covered,  
braided or plain). BUSS OR CON-  
NECTING WIRES.

JOHN A. ROEBLING'S SONS CO.  
Trenton, N. J. Branches in Principal Cities

**SM**

**STRAITLINE AUDIO DEVICES**

**NOT FOR PUBLICATION—**

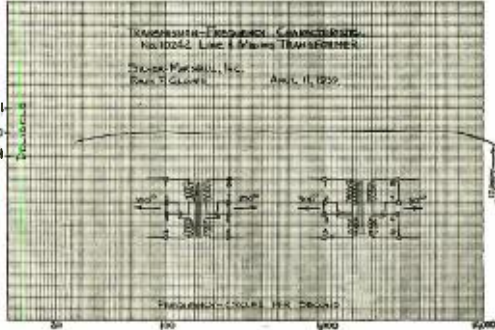

**—BUT GOOD ENOUGH TO PRINT!**

The remarkably uniform curve shown above is typical of the new series of Straitline Audio Transformers and Reactors—less than *half a decibel* total variation from 30 to 12,000 cycles—more than "good enough" for the highest quality broadcast and sound transmission systems!

Hand-wound and laboratory checked for performance—but reasonably priced!

Write for specification sheets covering complete new line of "Straitline" transformers and prices.

**SILVER-MARSHALL, Inc.**

6401 West 65th Street

Chicago, U. S. A.

Export Division: 41 Water Street, New York City, U. S. A.

THE PROSPECTIVE CUSTOMER DEMANDS

**GOOD  
CLEAR  
TONE**

SEVEN TONE ADJUSTMENTS . . . CONSTANT CAPACITY . . . MOISTURE PROOF . . . RUGGED CONSTRUCTION . . . ELIMINATES RESISTANCE STRIP . . . VERY COMPACT . . . HIGH VOLTAGE TEST . . . LIFE TEST UNEQUALED.

PRICED RIGHT

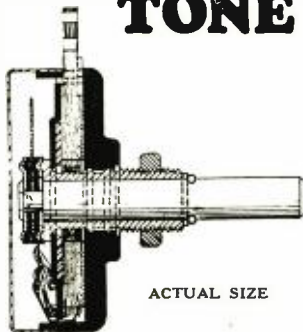

**SOUND EXPERTS APPROVE  
The OCTAVE TONE CONTROL**

A NEW TAPPED CONDENSER WITH SEVEN POSITIVE ADJUSTMENTS OF CAPACITY ELIMINATING THE RESISTANCE STRIP.

**FREE SAMPLES** MADE TO YOUR SPECIFICATIONS

**FILTERMATIC MFG. CO.**

HUNTING PARK AVE. AND MARSHALL ST.  
PHILADELPHIA PENNA.

**EASY**

**AS  
CUTTING  
PAPER**

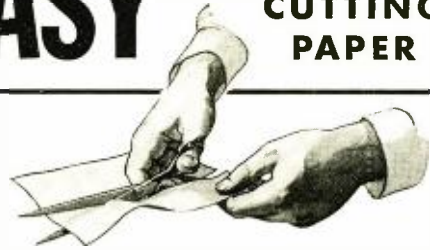

**Set Manufacturers  
Have Standardized  
on KESTER SOLDER!**

MANUFACTURERS began building better sets when they began using Kester Solder. Kester's self-contained flux is plastic rosin — it will not decompose because air and moisture are kept out. Kester plastic rosin flux is a non-conductor and it won't corrode. Purest virgin metals in Kester . . . even exceed-

ing Class A purity requirements of the A.S.T.M. And lastly, Kester is as simple as it is safe . . . a cinch to use! Our Industrial Development Department stands ready to prepare a more active flux for the special cases that need it. Write now for our booklet, "Facts on Soldering." It's free!

Kester Solder Company, 4224 Wrightwood Ave., Chicago, Ill. Eastern Plant, Newark, N. J. Canada—Kester Solder Company of Canada, Ltd., Brantford.

**KESTER  
FLUX-CORE  
SOLDER**  
Acid-Core • Paste-Core • Rosin-Core

*easy to use*

*The  
Proved  
Condensers  
For Tuning*



**INTERMEDIATE  
TRANSFORMERS**

Specially tested Isolantite base mounts inside transformer shield. Self-aligning phosphor-bronze adjustable spring plates, double rivetted. Selected mica insulation. Proved design—will not change in resistance or capacity from humidity, temperature or vibration. Forty ranges in single or double models—10 to 2100 mmf.

Hammarlund presents also a brilliant new Midget Condenser, with Isolantite insulation. Single or dual—20 to 325 mmf. per section.

*Mail Coupon for samples and quotations*

For Better Radio  
**Hammarlund**  
PRECISION  
PRODUCTS

HAMMARLUND MFG. COMPANY  
424 135 West 33rd St. New York  
Please send me Sample of Frequency Transformer Tuning  
Intermediate Frequency Transformer Tuning  
New Midget and condensers  
Name \_\_\_\_\_  
Address \_\_\_\_\_  
City \_\_\_\_\_  
State \_\_\_\_\_  
Zip \_\_\_\_\_  
RE-3

**An added SAFETY FACTOR!**

**VOLTOX**

(A Super Oxided Resistance Wire)

**A new Gilby Product**

Voltox has capacity for 6 to 8 volts at a time. It is particularly suitable for potentiometer and rheostat winding. It appears to be enameled, can be worked into very close turns and is exceptionally elastic. Our engineers will tell you more about it. Write for data.

*Gilby Processed  
Carbonized Nickel  
For Plates  
Gilby Patented  
Selvage Mesh*



**GILBY WIRE COMPANY**

150 Riverside Ave., Newark, N. J.

*Nickel-Chrome  
Resistance Wire  
Copper-Nickel  
Resistance Wire  
Nickel Wire and Sheet*



**ELMENCO**

**QUALITY PARTS FOR  
QUALITY PRODUCTS**

**RESISTORS**

CARBON  
WIRE WOUND  
VITREOUS  
ENAMEL  
STRIP AND  
FLEXIBLE



**Condensers**

BAKELITE  
MICA  
PAPER  
CARTRIDGE

**ASK FOR SAMPLES**

Our years of experience, combined with best of engineering and manufacturing facilities have made us the leader in this field, and the choice of the most prominent Radio Manufacturers.

**Our Quality and Service are the Best  
Our Prices Will Satisfy You**

**ELECTRO-MOTIVE ENG. CORP.**

797 E. 140 St.



NEW YORK

**The MARCY**

**LAKE PLACID, N.Y.**

**VACATION SPOT  
SUPREME!**

Rolling mountains . . . beautiful lakes . . . boating . . . swimming . . . riding . . . dancing . . . golf . . . tennis . . . these and numerous other attractions are offered by Lake Placid's only fire-proof hotel.

**The Marcy**

American Plan

RATES TO FIT  
EVERY PURSE



**SALES ENGINEER**

A prominent manufacturer of radio tubes requires the services of a Sales Engineer of proven ability.

He must be possessed of a sound basic knowledge of receiving set circuits, and must be an able consultant in engineering phases of new circuit designs. While not necessarily a tube engineer, a fundamental working knowledge of Radio Tubes and their various applications is essential.

A reasonable knowledge of selling is highly desirable; the ability to intelligently present commercial angles is imperative. Personal character must be above reproach.

If you measure up to the foregoing qualifications, can provide verification of favorable past experience, are willing to energetically, aggressively, and capably fulfill the duties of a Radio Sales Engineer, you are invited to write us in detail. Your communication will be treated confidentially.

Members of our staff have been advised of this insertion. Kindly address your communication to Box 95, care of Radio Engineering, 19 East 47th St., N. Y. C.

**MICROPHONES . . .  
OF ALL TYPES**

SHURE Microphones are world-famous for their SENSITIVITY and true, natural TONE quality. This performance is attained by a combination of several features not to be found in any other microphone. You should have our catalog sheets with detailed specifications on file. Write today.



*Write for Details*

**SHURE BROTHERS COMPANY**

Manufacturers-Engineers

S. N. SHURE, Pres.

337 WEST MADISON ST.

CHICAGO, ILLINOIS



# KELLOGG Condensers..

**FILTER » BY-PASS » IGNITION » TELEPHONE » TELEGRAPH  
COILS » TRANSFORMERS » HOOK-UP WIRE** *{ All types of braided "Push-back" wire, spe-  
cially processed for high insulation resistance. }*

*Write for No. 66 Radio-Industrial Catalog on your company letterhead*

**Kellogg Switchboard and Supply Company**  
1066 West Adams Street . . . CHICAGO, ILLINOIS

## MEASURE CAPACITANCE

» » » SPEED & ACCURACY « « «

FOR CONVENIENCE, SPEED, AND ACCURACY IN THE MEASUREMENT OF CAPACITANCE, THERE IS NOTHING THAT CAN EQUAL A WELL DESIGNED BRIDGE. GENERAL RADIO HAS A COMPLETE LINE OF CAPACITY BRIDGES OF VARIOUS TYPES, WITH THE TYPE 240 CAPACITY METER AS A GENERAL-PURPOSE INSTRUMENT.

THE TYPE 240 CAPACITY METER COVERS THE RANGE BETWEEN 11.1 MICROFARADS AND 1000 MICROMICROFARADS WITH AN ACCURACY OF ABOUT 0.3%. IT MEASURES POWER FACTOR AS WELL AS CAPACITANCE, ONE MEASUREMENT GIVING NOT ONLY THE SIZE OF THE CONDENSER UNDER TEST BUT ITS LOSSES AS WELL.

WE RECOMMEND THIS BRIDGE FOR TESTING AND INSPECTION WORK OF ALL KINDS. WRITE FOR DATA. ITS PRICE IS \$85.00.

**GENERAL RADIO COMPANY**  
CAMBRIDGE, MASSACHUSETTS

## LAMINATIONS

**for Audio & Power Transformers**  
SPECIALIZED METHODS—YEARS OF EXPERIENCE  
Wide Variety of Stock Standard Sizes

*Dimension and Price Sheets on request*

**We Also Make**

PERMANENT MAGNETS—DIES—TOOLS—  
METAL STAMPINGS

*Facilities for prompt service*

**Thomas & Skinner Steel Products Co.** 1100 to 1120  
E. Twenty-Third St. INDIANAPOLIS, IND.

## Volume Indicator Panel



For Broadcast Speech Input Systems,  
Recording and Public Address Installations.  
Rectifier type, laboratory calibrated with

Range -16 DB to +32 DB

Mounted on Standard 19" x 7" x 1/4" Black  
Enameled Aluminum Panel.

Price in U. S. A. net f.o.b. Chicago  
(Code LISPS) ..... \$80.00

*Send for Bulletin 8C*

**JENKINS & ADAIR, INC.**  
ENGINEERS  
CHICAGO, U. S. A.

Cable Address: JENKADAIR  
3333 Belmont Avenue  
Phone: Keystone 2130  
British Offices: 78 Old Hall Street, Liverpool  
40 Buckingham Gate, London, S.W. 1  
French Office: 16 Rue de Chateaudun, Asnières  
Mexican Office: Av. 5 de Mayo 10, Mexico, D. F.  
Indian Office: Ismail Bldg., Hornby Road, Fortin, Bombay  
43/1 D Dharamola Street, Calcutta  
Japanese Office: 9 Minami-Sumiyama-Machi, Osaka  
Chinese Office: 20 Nanking Road, Shanghai

## PHOTO ELECTRIC CELLS

MOST SENSITIVE AND POWERFUL  
ON THE MARKET



Cotron Cells are made by a totally different process for making caesium argon cells—licensed under patents and applications of the McIlvaine Patent Corporation. These cells not only have the highest ionization point, but the greatest reliability as well, and are noted for their extremely long life. Used extensively for motion picture, television and other applications.

*Interesting Data for Reliable Distributors.*  
**CONTINENTAL ELECTRIC CO.**  
ST. CHARLES, ILLINOIS

**TRU-VAC VACUUM GAUGES**

will give you readings on an electric meter of exact pressures and microns of water, vapor gases and air in any vacuum system.  
**FACTORY REPRESENTATIVES WANTED**



# Textolite Laminated

A  
"GENERAL ELECTRIC"  
PRODUCT

PUNCHING—MACHINING  
Sheets—Rods—Tubing  
All sizes carried in stock

GENERAL FABRICATING COMPANY  
37 East 18th Street, New York City

OUR PROMPT SERVICE—is  
a valuable asset in co-ordi-  
nating your production work.



## MIDWEST CONDENSER MICROPHONES

Specifications of suspension model No. 150:  
TUBES—2 type 864  
OUTPUT LEVEL—Minus 25db.  
OUTPUT IMPEDANCE—200 or 50 ohms  
UNIFORM RESPONSE—30 to 10,000 cycles  
PHYSICAL DIMENSIONS—3 1/4" in diameter  
11" in height  
REVOLVING SWIVEL HEAD

Remarkably low price.

MIDWEST BROADCAST EQUIPMENT COMPANY  
6007 Diversey Avenue Chicago, Ill.

## BRASS—BRONZE—COPPER NICKEL SILVER—ZINC PHOSPHOR BRONZE

In Gauges .001 and Thicker. 1/16" to 16" Wide  
HOT TIN COATED METALS IN COILS AND STRIPS

THE BALTIMORE BRASS CO.  
1206 WICOMICO ST., BALTIMORE, MD.

## WAXES, COMPOUNDS and VARNISHES

for insulation of condensers

transformers, coils, power packs, pot heads, sockets, wiring devices, wet and dry batteries, etc. . . . WAX SATURATORS for braided wire and tape. WAXES for radio parts. . . . Compounds made to your own specifications if you prefer.

ZOPHAR MILLS, INC.

Court and Lorraine Streets Founded 1846 Brooklyn, N. Y.

## NICKEL CUT For Radio Tubes FLAT ENDS

between .070 and .006 dia.  
±.002"—no burrs—every piece straight  
Capacity 10,000,000 pieces daily

Small metal parts to your blue print. 100 to 675,000 pieces per lb.

Art Wire and Stamping Company  
18-22 Boyden Place, Newark, N. J.

## PIEZO-ELECTRIC CRYSTALS

Since 1925 we have been recognized as the RELIABLE PRODUCERS of POWER CRYSTALS. We are at your service to supply your needs. Special prices for quantity lots. Your request will bring our price list.

SCIENTIFIC RADIO SERVICE

"The Crystal Specialists"

124 Jackson Avenue, University Park, Hyattsville, Maryland

## When You Renew Your Subscription to RADIO ENGINEERING

Remember the Group Rate—\$1.00 a year for four or more subscriptions.

Regular Rate—\$2.00 a year in U. S. A.—\$3.00 in foreign countries

## NEW! Dual Ratio Dial for All-Wave Sets

WRITE FOR SAMPLE AND PRICES

Eddie Mfg. Co., 9 W. Illinois St., Chicago

## CONDENSER PAPER

182 Cornelson Ave. — Mills at — Newark Ave.  
Jersey City, N. J. Elizabeth, N. J.

PETER J. SCHWEITZER, Inc.,  
200 Fifth Ave. New York

## PROTECT those INSTRUMENTS

Littelfuses afford complete protection for voltmeters, milliammeters, tube testers, etc. Range in size from 1/100 to 2 amps. capacity.

Also Radio Receiver and Amplifier Littelfuses, and High Voltage Littelfuses for transmitting tubes, rectifiers, oscillators, etc.

Write for instructive catalog.

LITTELFUSE LABORATORIES

1778 WILSON AVE. CHICAGO, U. S. A.

"Quicker than a Short circuit" **LITTELFUSES**

## COILS Choke-Impedance — : : — Magnet-Transformer TRANSFORMERS

Audio—B-Power Unit—Broadcast Station—Output  
Filament Heating—Power—Stepdown

Have us quote to your specification

POWER TRANSFORMER CO., 36 E. 22nd St., New York City



PRESS  
DOWN  
HERE

## FAHNESTOCK CLIPS

Standard in the Radio Industry

Made in 58 Sizes and Shapes

Send for Samples and Prices

FAHNESTOCK ELECTRIC COMPANY—Long Island City, N. Y.

# THERE IS A DIFFERENCE!

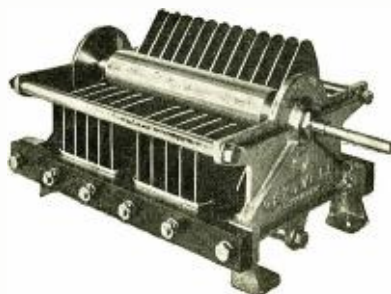

For all practical purposes, transmitting condensers may be divided into two classes, those that are **BUILT FOR TRANSMITTING** and those that merely **LOOK** as though they were. The name **CARDWELL** on a transmitting condenser dispels any doubt as to the class to which it belongs.

There are many **CARDWELL** condensers **BUILT FOR TRANSMITTING**. They range from small condensers in many capacities to giant condensers for high powered installations.

There is nothing of the shrinking violet about **CARDWELL** receiving condensers either. They are **BUILT FOR SERVICE** and look it.

Send for literature

THE ALLEN D. CARDWELL MFG. CORP'N.  
91 Prospect Street Brooklyn, N. Y.

## CARDWELL CONDENSERS AND MANUFACTURING SERVICE

'' THE STANDARD OF COMPARISON ''

### Recording on Metal

If you are interested in this new and profitable branch of Radio, get your name on our mailing list for our new bulletin describing our Crystal cutting head and complete recorders.

Astatic Microphone  
Laboratory

21 Olive Street, Youngstown, O.

### TELEPHOTO

#### CAESIUM ARGON PHOTOELECTRIC CELLS



Highly sensitive, Telephoto cells reduce the amount of amplification required for tonal reproduction, obviating to a remarkable extent the possibility of distortion . . . the results of painstaking supervision in each detail of construction, of rigid adherence to high and scientific standards of achievement. Telephoto cells are guaranteed to last 6 months.

TELEPHOTO & TELEVISION CORPORATION

Pamphlet on request

133-135 West 19th St. New York

## CANDOHMS

ARMoured WIRE WOUND RESISTORS  
WILL LOWER YOUR COSTS—May we sample and quote

**The Muter Company**

1255 S. Michigan Ave.

CHICAGO, ILL.

1922 **GATES AMPLIFIERS** 1922  
FOR THEATRES, BROADCASTING STATIONS & ADDRESS SYSTEMS  
**GATES RADIO & SUPPLY CO.**  
1932 QUINCY, ILLINOIS, U. S. A. 1932

### MICROPHONE REPAIRS

You may now have the expert services of our laboratories for the repair of Microphones of *any make*. A 24 to 48-hour schedule is maintained to enable you to get your equipment back without loss of time. All work is fully guaranteed. Prices very *reasonable*. Write for our quotation stating type of microphone and description of what is wrong with the unit.

Try this service now. It saves you time and money!

### SHURE BROTHERS COMPANY

Manufacturers-Engineers  
S. N. SHURE, Pres.

337 WEST MADISON ST. CHICAGO, ILLINOIS

WE offer to manufacturers interested in

## EXPORT

the services of a dependable organization, well established in the entire foreign field

**AD. AURIEMA, INC.**

Manufacturers' Export Managers

116 Broad Street, New York, N. Y.

## Rocke International Electric Corp.

15 Laight Street, New York City

Export Managers

Radio—sound equipment—Electric Products

# NEW UNITED SCIENTIFIC LAB. VARIABLE CONDENSER

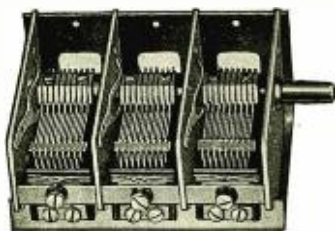

This new type "D" Condenser is designed to meet the commercial requirements of all types of present day receivers. All coupling effects have been eliminated and accurate tuning adjustment of all sections is assured. Other exclusive features make this condenser the outstanding tuning unit, measuring up to the rigid standards of the United Scientific Laboratories.

Available in clock or counter-clock wise rotation with trimmers, in one, two or three gang units in capacities from .00015 to .00042 MFD.

*Write for circular giving full specifications. Let us quote on your particular requirements.*

**United Scientific Laboratories, Inc.**  
62 WEST 14th ST. NEW YORK CITY

# DEPENDABLE

QUALITY—UNIFORMITY  
SERVICE

ON

WAXES—&—MELTABLE  
INSULATING and WEATHER-  
PROOFING COMPOUNDS

WAXES—All kinds.

IMPREGNATIONS—Condensers, Coils, Rubber-Covered and Weather-Proofed Wire, Telephone and Electrical Cables, Etc.

SEALING COMPOUNDS—Coils, Condensers, Batteries (Wet & Dry), Pot Heads, Cables, Wiring Devices and Specials.

FINISHING—All grades of Weather Proof and Rubber-Covered Wire.

SPECIAL COMPOUNDS



35th St. & Maplewood Ave.  
Chicago, Ill.

"For over 35 yrs."

# INDEX OF ADVERTISERS

<b>A</b>		<b>G</b>		<b>O</b>	
Acme Wire Co., The.....	46	Gates Radio & Supply Co.....	49	Ohio Carbon Co., The.....	33
Ad. Auriema, Inc.....	49	General Electric Co.....	12	<b>P</b>	
American Transformer Co.....	42	General Fabricating Co.....	48	Parker-Kalon Corp.....	5
Arcturus Radio Tube Co., Second Cover		General Plastics, Inc.....	1	Phelps Dodge Copper Products Corp.....	9
Art Wire & Stamping Co.....	48	General Radio Co.....	47	Pines Winterfront Co.....	39
Astatic Microphone Lab.....	49	Gilby Wire Co.....	46	Power Transformer Co.....	48
		Graybar Electric Co.....	33	<b>R</b>	
<b>B</b>		<b>H</b>		<b>S</b>	
Bakelite Corp.....Back Cover		Hammarlund Mfg. Co.....	45	Schweitzer, Peter J., Inc.....	48
Baltimore Brass Co., The.....	48	<b>I</b>		Scientific Radio Service.....	48
<b>C</b>		Inca Manufacturing Division.....	9	Shakeproof Loek Washer Co.....	11
Candy & Co.....	50	International Broadcasting Equip. Co.....	10	Shure Brothers Co.....	46, 49
Cardwell Mfg. Co., Allen D.....	49	<b>J</b>		Silver-Marshall, Inc.....	45
Central Radio Laboratories.....	41	Jenkins & Adair, Inc.....	47	<b>T</b>	
Chicago Telephone Supply Co.....	8	Jewell Electric Instrument Co.....	52	Telephoto & Television Corp.....	49
Condenser Corp. of America.....	52	Johnston Tin Foil & Metal Co., The.....	44	Thomas & Skinner Steel Products Co.....	47
Continental Electric Co.....	47	<b>K</b>		Thordarson Electric Mfg. Co.....	41
Crowe Name Plate & Mfg. Co., Third Cover		Kellogg Switchboard & Supply Co.....	47	<b>U</b>	
<b>D</b>		Kester Solder Co.....	45	United Scientific Laboratories.....	50
DeVry, Inc., Herman A.....	43	<b>L</b>		<b>W</b>	
Dubilier Condenser Corp.....	42	Lebel High Frequency Lab., Inc.....	44	Western Electric Co.....	36
<b>E</b>		Littelfuse Laboratories.....	48	White Dental Mfg. Co., The. S. S.....	39
Eddie Manufacturing Co.....	48	LuxTron Mfg. Co., Inc.....	51	<b>Z</b>	
Electro-Motive Engineering Corp.....	46	<b>M</b>		Zapon Company.....	43
<b>F</b>		Midwest Broadcast Equipment Co.....	48	Zophar Mills, Inc.....	48
Fahnestock Electric Co.....	48	Muter Company, The.....	49		
Filtermatic Mfg. Co.....	45				
Frost, Inc., Herbert H.....	8				

**T**HE Group Subscription Plan for RADIO ENGINEERING enables a group of engineers or department heads to subscribe at one-half the usual yearly rate.

The regular individual rate is \$2.00 a year. In groups of 4 or more, the subscription rate is \$1.00 a year. (In Canada and foreign countries \$2.00.)

The engineering departments of hundreds of manufacturers in the radio and allied industries have used this Group Plan for years, in renewing their subscriptions to RADIO ENGINEERING.

Each subscriber should print his name and address clearly and state his occupation—whether an executive, engineer, department head, plant superintendent, or foreman, etc.

Remember this Group Plan when *Your* Subscription Expires

(Radio Engineering)

Bryan Davis Publishing Co, Inc.  
19 East 47th Street  
New York, N. Y.

Los Angeles

Chicago

Cleveland

## ACME WIRE PRODUCTS

All ACME products are made to recognized commercial standards, including those of:

Nat'l Electric Mfrs. Assn.  
Radio Manufacturers' Assn.  
Amer. So. for Testing Materials.

**Magnet Wire**  
(All Insulations)

**Parvolt Condensers**  
(Filter and By-Pass)

Also Condensers for Power Factor Correction

**Coils, Magnet Wire Wound**

**Varnished Insulations**  
(Cambric, Paper, Silk, Tape)

**Aerial Wire**

(Stranded and Solid)

For over 25 years, suppliers to the largest radio and electrical manufacturers.

**THE ACME WIRE CO.**

New Haven, Conn.

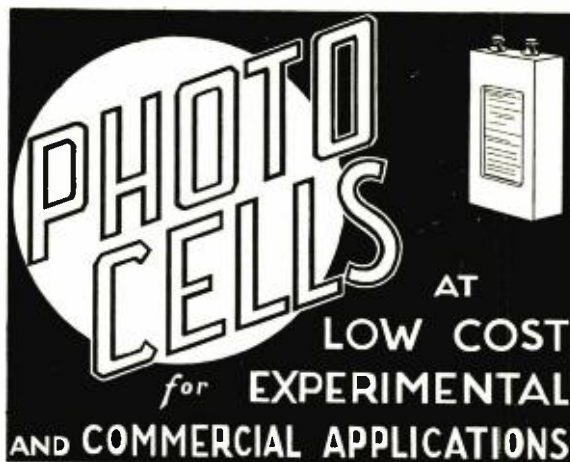

**PHOTO CELLS** AT LOW COST  
for EXPERIMENTAL AND COMMERCIAL APPLICATIONS

The LuxTron "ST" Cell requires no amplification. It operates at 22½ volts. With a 40 watt frosted lamp at 12" it gives a minimum of 2 milliamps photo-potential. It is the lowest priced practical photo cell on the market. The ideal photo cell for thousands of experimental and commercial uses. Every LuxTron cell is photometrically tested and fully guaranteed.

"ST" Cell Priced at \$3.50

The LuxTron "R-1" Relay will handle 110 volts, 1 amp., without arcing or sparking. It is designed especially for use with the LuxTron "ST" Cell. Positive and rapid in its action. No amplifier needed. The "R-1" type Relay is priced at \$4.00 (less case).

LuxTron engineers are prepared to give expert advice on all phases of the light-control art.

SEND FOR INTERESTING LITERATURE ON LUXTRON CELLS AND RELAYS

**LUXTRON MFG. CO., INC.**

Pioneers in Photo Cell Devices Since 1900

241 Lafayette Street Dept. RE New York, N. Y.

# A Complete Service!

## Instruments Plus Application Engineering



### Jewell Master Portables

High resistance direct current voltmeters, capacity meters, and ohmmeters are available in addition to the standard A. C., D. C., and thermocouple indicating instruments. Sturdy molded bakelite cases of uniform size and easy-to-read mirror type scales of 4-7/16 inch lengths are two reasons for their wide usage in laboratory and production testing.

### Jewell Pocket Portables

Unusually long mirror type scales are available in these compact instruments. Direct current and thermocouple types are provided in single and multiple range instruments with range combinations to meet every measuring need. Also offered as an ohmmeter with self-contained battery and compensator for battery voltage change.



### Jewell Panel Instruments



A complete selection of panel mounting instruments ranging from 4 3/4 inches to 2 1/4 inches case diameter. The 2 3/4 inch bakelite case line offers A. C., D. C., rectifier type A. C. current, and thermocouple type high frequency instruments that are interchangeable in the same mountings.

The movements used in these instruments have stamina proven by years of service in such applications as arc welders, airplane control panels, and radio service equipment, where the most severe conditions are encountered.

### Jewell Engineering Service

The specialized skill and experience of Jewell instrument engineers are instantly available without obligation to assist in any design problem involving electrical measuring instruments. Get in touch with your local Jewell representative or the Jewell factory.

Jewell Electrical Instrument Company  
9 Haynes Avenue, Newark, New Jersey

32 YEARS MAKING INSTRUMENTS  
**JEWELL**

## ENGINEERS • for the last word in condenser design and construction

### • SPECIFY the new ACRACON SEMI-DRY ELECTROLYTIC UNIT



*Note These Features:*

- peak operating voltage 500
- surge voltage 600
- low initial leakage
- leakage current at 500 volts less than .2 mils per mfd.
- constant capacity; does not decrease with age
- stable power factor; does not increase with age
- non-corrosive connections
- metal or fibre container
- standard and special sizes

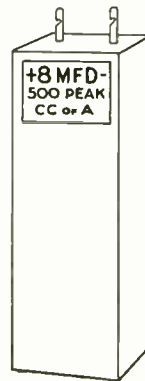

**WRITE TODAY FOR DESCRIPTIVE LITERATURE!**

*\*Acraccon Features Are Protected  
by Patents Pending*

## CONDENSER CORP. of AMERICA

259 Cornelison Ave., Jersey City, N. J.

*Factory Representatives in:*

Chicago Cincinnati San Francisco  
St. Louis Los Angeles Toronto

*And Other Principal Cities*

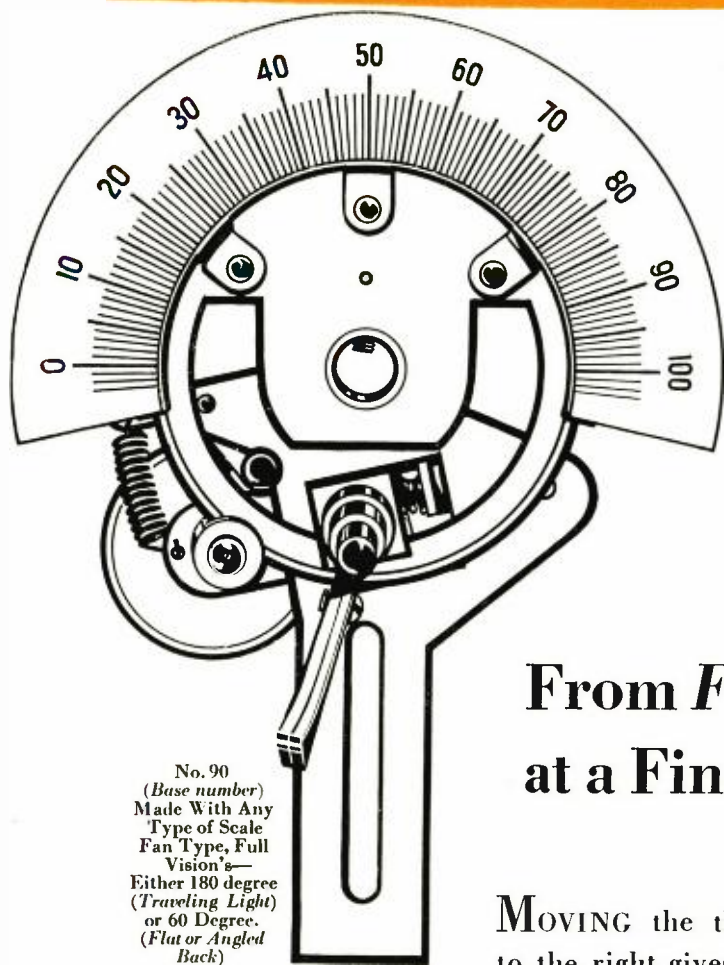

# NO. 90 TWO SPEED WEDGE DRIVE TUNING CONTROL

*From Fast to Slow  
at a Finger's Touch*

No. 90  
(Base number)  
Made With Any  
Type of Scale  
Fan Type, Full  
Vision's—  
Either 180 degree  
(Traveling Light)  
or 60 Degree.  
(Flat or Angled  
Back)

MOVING the thumb lever to the right gives a 6 to 1 ratio. When thrown to the left affords a 30 to 1 ratio, both ratios in 180 degrees.

An ideal control for combination Broadcast and Short Wave Sets or for accurate Short Wave work of any sort. Valuable on superheterodynes when fine tuning is desirable.

Scales of the fan type are in various sizes and multi-channel calibrations in kilocycles or megacycles are made to order.

When writing furnish definite specifications as to scale, direction of reading and size of condenser shaft.

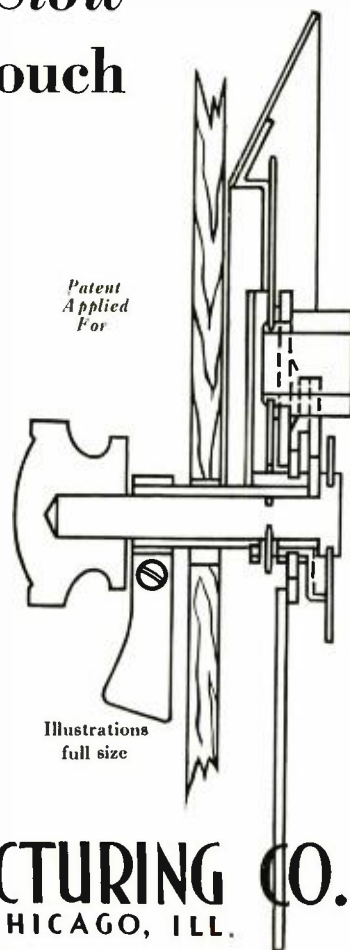

**CROWE NAME PLATE & MANUFACTURING CO.**  
1747 GRACE ST. CHICAGO, ILL.

# In the Broadcasting Station ...insulations must be dependable

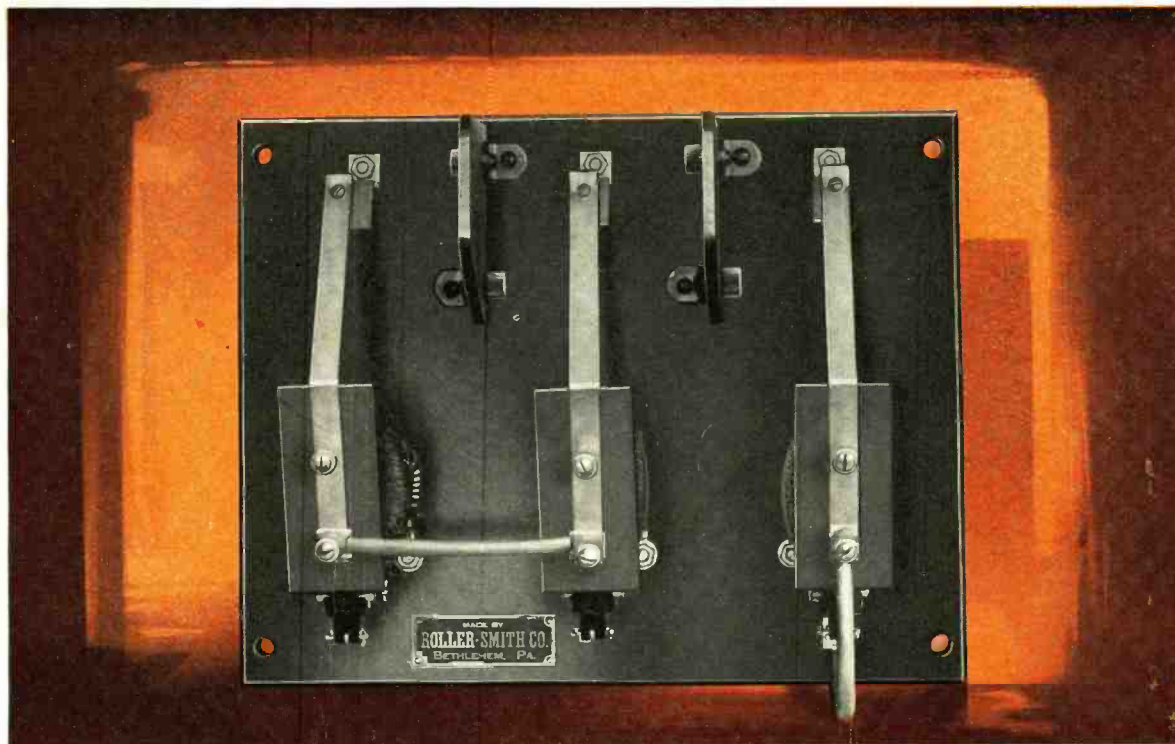

Contacter made by Roller Smith Company, New York City

ON THE AIR, often from six in the morning until three the next, broadcasting equipment must be dependable. Overcrowded ether channels require apparatus that is extremely accurate in performance. The dependability and accuracy of most of this equipment depends upon the efficiency of its insulations. That is why Bakelite Materials are so widely used in broadcasting stations.

Bakelite Laminated provides dependable insulation for the Roller Smith contactor shown above. The base, separators and bushings of

this 5 ampere, 3000 volt device are made of strong insulating Bakelite Laminated. Moisture will not impair this material's insulating efficiency nor will hard wear or chance blows destroy it.

Whether in the Molded, Laminated or Varnish form, Bakelite Materials possess ideal properties for use as insulating materials in the electronics industry. Strong, highly insulating, non-corrodible and non-hygroscopic—these materials give constant and dependable service for a long period of time. We invite

you to avail yourself of the assistance of our laboratories and engineers.

Write for illustrated booklet 12L, "Bakelite Laminated", which further describes this material—its properties and uses.



BAKELITE CORPORATION, 247 Park Avenue, New York, N. Y. . 635 West Twenty-Second Street, Chicago, Ill.  
BAKELITE CORPORATION OF CANADA, LIMITED, 163 Dufferin Street, Toronto, Ontario, Canada

## BAKELITE

The registered trade name, shown above, designates materials manufactured by Bakelite Corporation. Under the capital "B" in the number of legs for utility, or patented purposes, is credited the office number of program and have use of Bakelite Corporation's products.

THE MATERIAL OF A THOUSAND USES